

GE Infrastructure
Sensing

Model CGA 351 *Zirconia Oxygen Analyzer*



User's Manual

910-199C

December 2004

The Model CGA 351 is a GE Panametrics product. GE Panametrics has joined other GE high-technology sensing businesses under a new name—GE Infrastructure Sensing.



Warranty

Each instrument manufactured by GE Infrastructure Sensing, Inc. is warranted to be free from defects in material and workmanship. Liability under this warranty is limited to restoring the instrument to normal operation or replacing the instrument, at the sole discretion of GE Infrastructure Sensing, Inc. Fuses and batteries are specifically excluded from any liability. This warranty is effective from the date of delivery to the original purchaser. If GE Infrastructure Sensing, Inc. determines that the equipment was defective, the warranty period is:

- one year for general electronic failures of the instrument
- one year for mechanical failures of the sensor

If GE Infrastructure Sensing, Inc. determines that the equipment was damaged by misuse, improper installation, the use of unauthorized replacement parts, or operating conditions outside the guidelines specified by GE Infrastructure Sensing, Inc., the repairs are not covered under this warranty.

The warranties set forth herein are exclusive and are in lieu of all other warranties whether statutory, express or implied (including warranties of merchantability and fitness for a particular purpose, and warranties arising from course of dealing or usage or trade).

Return Policy

If a GE Infrastructure Sensing, Inc. instrument malfunctions within the warranty period, the following procedure must be completed:

1. Notify GE Infrastructure Sensing, Inc., giving full details of the problem, and provide the model number and serial number of the instrument. If the nature of the problem indicates the need for factory service, GE Infrastructure Sensing, Inc. will issue a RETURN AUTHORIZATION number (RA), and shipping instructions for the return of the instrument to a service center will be provided.
2. If GE Infrastructure Sensing, Inc. instructs you to send your instrument to a service center, it must be shipped prepaid to the authorized repair station indicated in the shipping instructions.
3. Upon receipt, GE Infrastructure Sensing, Inc. will evaluate the instrument to determine the cause of the malfunction.

Then, one of the following courses of action will then be taken:

- If the damage is covered under the terms of the warranty, the instrument will be repaired at no cost to the owner and returned.
- If GE Infrastructure Sensing, Inc. determines that the damage is not covered under the terms of the warranty, or if the warranty has expired, an estimate for the cost of the repairs at standard rates will be provided. Upon receipt of the owner's approval to proceed, the instrument will be repaired and returned.

Table of Contents

Chapter 1: General Information

Introduction.....	1-1
The Sensor Enclosure.....	1-2
The Sample System	1-3
Principles of Operation	1-4
The Zirconia Oxygen Sensor	1-5
The Heater Control Circuit	1-6

Chapter 2: Installation

Introduction.....	2-1
Choosing an Installation Site.....	2-2
Mounting the Model CGA 351	2-3
Connecting the Sample System.....	2-4
Wiring the Analyzer	2-5
Wiring the Outputs (TB1)	2-6
Wiring the Inputs (TB2).....	2-7
Wiring the Line Power (TB3)	2-8

Chapter 3: Operation

Introduction.....	3-1
Preventing Common Problems.....	3-1
Powering Up the System.....	3-2
User Program Security.....	3-2
Configuring the Digital Display.....	3-3
Initial Screen Displays	3-4
Configuration Options	3-5
Switching Display Windows.....	3-6
Converting mV to Oxygen Concentration.....	3-8
Powering Down	3-8

Table of Contents (cont.)

Chapter 4: Setup and Calibration

Introduction	4-1
Accessing the User Program	4-1
The [Cal] Menu	4-2
Setting Up the Alarm Relays	4-2
Setting the Trip Type	4-3
Setting the Trip Value	4-4
Setting the Deadband Value	4-5
Testing the Alarm Relays	4-6
Selecting the Operating Mode	4-7
Setting the Temperature Controls	4-8
Entering the Setpoint	4-9
Setting the Air Offset	4-10
Setting the Proportional Band	4-11
Setting the Integration Time	4-12
Setting the Maximum Duty Cycle	4-13
Restoring the Default Values	4-14
The [Opt-User] Menu	4-15
Setting Fault Alarm Type	4-15
Setting Up the Analog Output	4-16
Selecting the Analog Output Type	4-18
Setting the Zero Setpoint	4-19
Setting the Span Setpoint	4-20
Testing the Analog Output	4-21
Setting the Zero Trim	4-22
Setting the Span Trim	4-23
Adjusting the Display Contrast	4-24
Setting the Display Backlight	4-25
Setting Up the Serial Port	4-26
Entering the Node ID	4-26
Entering the Baud Rate	4-26
Entering the Number of Data Bits	4-27
Entering the Parity	4-27
Entering the Number of Stop Bits	4-27
Selecting the Type of Serial Port	4-27
Setup and Security Settings	4-28
Setting Up the Option Card Slots	4-28
Setting the Security Levels	4-30
Calibrating the Model CGA 351	4-31
Recommended Calibration Gas	4-31
Regulating the Calibration Gas Flow Rate	4-32
Adjusting the Calibration Setting	4-33
Checking the Current Settings	4-36
Checking the Sensor Impedance	4-37
Viewing the Heater Settings	4-37

Table of Contents (cont.)

Chapter 5: Service and Maintenance

Introduction.....	5-1
General Troubleshooting.....	5-1
Checking the Wiring.....	5-2
Checking the Thermocouple.....	5-3
Checking the Oxygen Sensor.....	5-5
Checking the Sensor Furnace.....	5-5
Checking the Sensor Furnace Voltage.....	5-6
Oxygen Measurement Errors.....	5-7
Oxygen Concentration Reads Constant 20.93%.....	5-7
Oxygen Reading Above 100%.....	5-9
Oxygen Reading Too Low.....	5-9
Oxygen Reading Too High.....	5-9
Calibration Responses.....	5-11
Everything Is Fine.....	5-11
Forced Flow Problem.....	5-11
Plugging or Dead Space Problem.....	5-11
Parts Replacement.....	5-12
The Sensor Enclosure.....	5-13
The Electronics Enclosure.....	5-20
Recommended Spare Parts.....	5-24

Chapter 6: Specifications

General Specifications.....	6-1
Operating Specifications.....	6-2
Ordering Information.....	6-3

Appendix A: The Nernst Equation

Introduction.....	A-1
Equilibrium Conditions.....	A-1
The Model CGA 351 Nernst Equation.....	A-2

Appendix B: CE Mark Compliance

Overview.....	B-1
EMC Compliance.....	B-1
LVD Compliance.....	B-1

Table of Contents (cont.)

Appendix C: Optional Enclosures

Introduction	C-1
Rack Mount Installation.....	C-1
Mounting the Rack Mount	C-1
Connecting the Sample System	C-2
Wiring the Rack Mount	C-2
Rack Mount Operation.....	C-4
Rack Mount Service and Maintenance	C-4
Parts Replacement	C-4
Replacing the Fuses	C-5

Chapter 1

General Information

Introduction.....	1-1
The Sensor Enclosure	1-2
The Sample System	1-3
Principles of Operation	1-4
The Zirconia Oxygen Sensor	1-5
The Heater Control Circuit.....	1-6

Introduction

The *Model CGA 351* monitors the oxygen content of any clean and dry gas stream. The analyzer can accurately measure oxygen levels from 0.1 ppm to 100% O₂, and can even measure oxygen content in reducing gases. This is accomplished with a precision, temperature-controlled, zirconium oxide (zirconia) oxygen sensor.

The standard CGA 351 analyzer is supplied in a pair of stainless steel, Nema 4X/IP66 enclosures mounted side-by-side on a metal plate with a 40" flexible conduit connecting the two. This compact, wall-mounted system includes the following components:

- a *sensor enclosure*, which contains the oxygen sensor, sensor furnace, thermocouple, inlet port with needle valve, outlet port with flowmeter, and interconnecting cable(s), and
- an *electronics enclosure*, which contains the temperature control circuitry, output signal processing circuitry, digital display, user interface, and wiring terminal strips.

The CGA 351 analyzer is also available in optional enclosures. See Appendix C for more information.



Figure 1-1: Standard CGA 351 Analyzer

The Sensor Enclosure

The sensor enclosure, which is shown in Figure 1-2 below, houses the sample measurement components. The functions of these components are as follows:

- a zirconium oxide (zirconia) *oxygen sensor* converts the oxygen concentration of the sample gas into a mV output signal.
- a *sensor furnace* heats the oxygen sensor and the sample gas to the optimum temperature of 700°C.
- a *thermocouple* precisely regulates the temperature of the oxygen sensor and the sample gas.
- an inlet *needle valve* and an outlet *flowmeter* adjust the sample gas flow to $1,000 \pm 150$ cc/min (2.1 ± 0.3 SCFH).

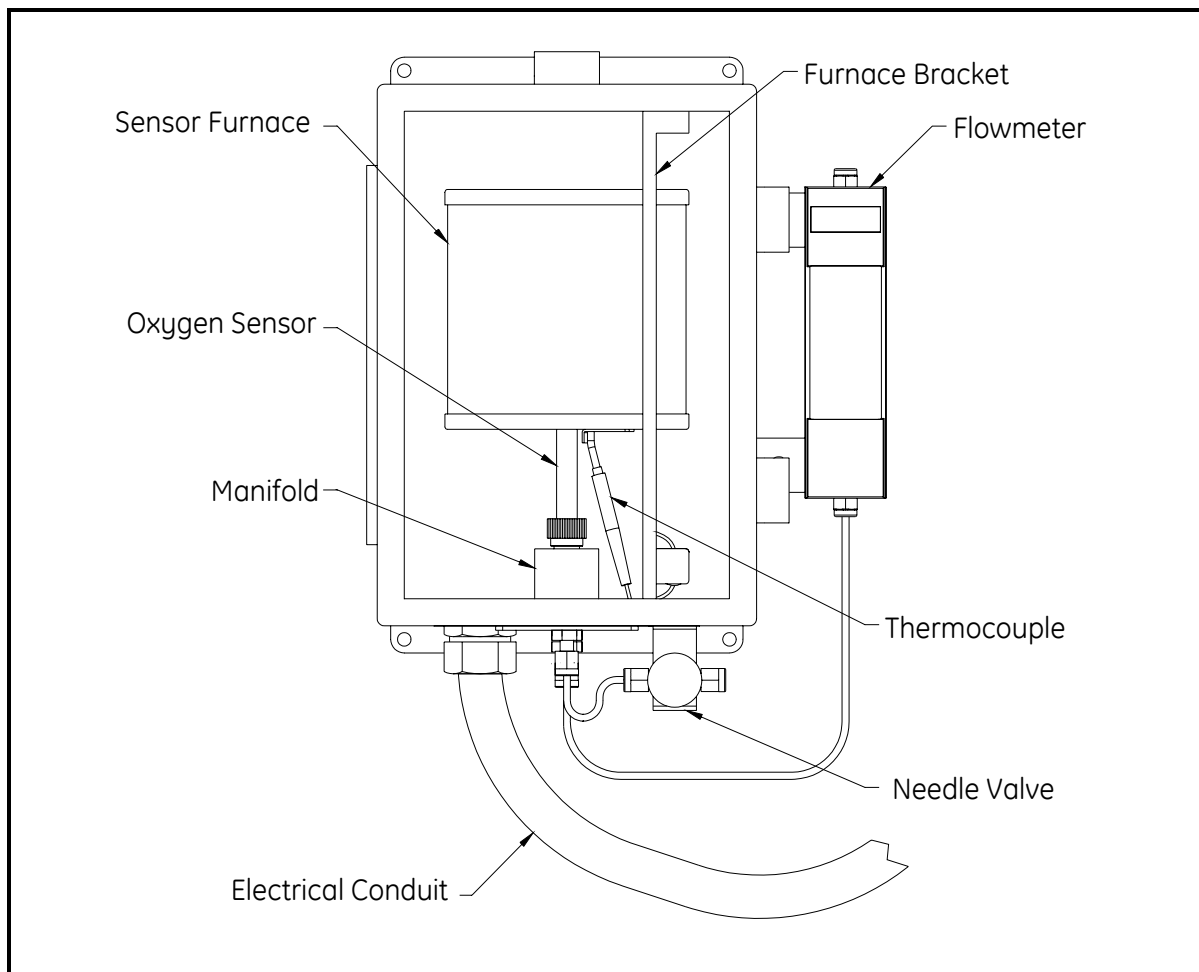

Figure 1-2: Sensor Enclosure

The Sample System

In addition to the components supplied with the CGA 351, an external sample system may be required to ensure that the analyzer is fed a properly conditioned sample or calibration gas stream. In particular, the gas must be clean and dry, and it must be delivered to the analyzer at atmospheric pressure.

Note: *A suitable sample system, which will be supplied completely assembled on its own mounting plate, may be ordered directly from the factory.*

Commonly used sample system components include filters, pressure regulators, pressure gauges, by-pass loops, and sample pumps. It is recommended that stainless steel construction be used for all wetted parts of the sample system. A typical sample system is shown in Figure 1-3 below.

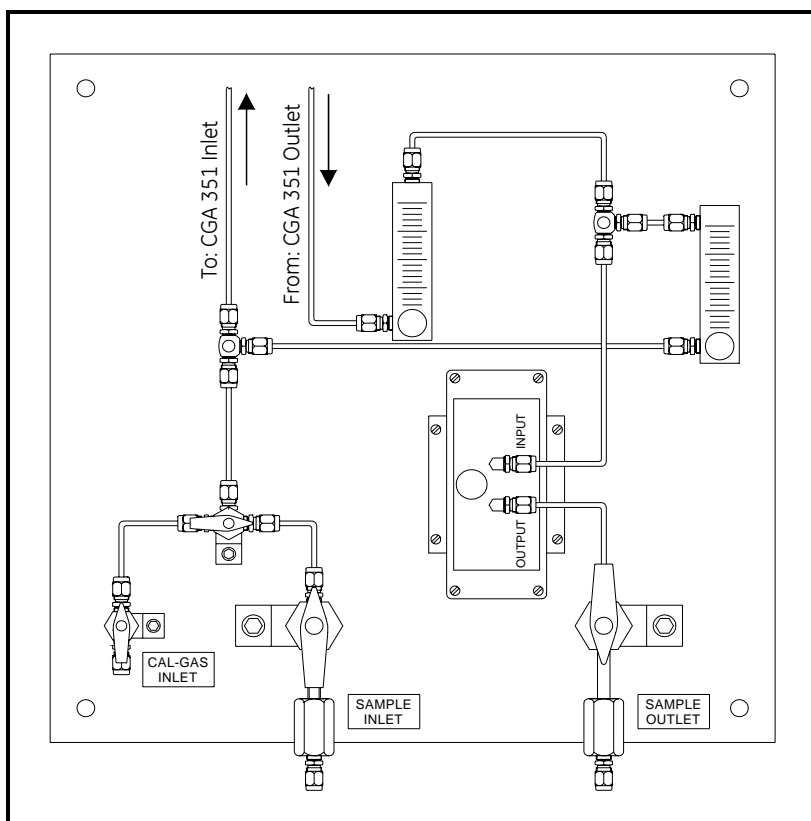

Figure 1-3: Typical Sample System

Principles of Operation

A gas sample is drawn into the inlet port of the analyzer by gas diffusion and a gentle convective flow. The sample gas then flows through a ceramic inlet tube and into the annular space between the inlet tube and the inside of the zirconia oxygen sensor. The flowmeter on the outlet port and the needle valve on the inlet port are used to adjust the sample flow rate to $1,000 \pm 150$ cc/min (2.1 ± 0.3 SCFH).

In the annular sample space, the gas is heated to the same 700°C at which the zirconia oxygen sensor is maintained. A mV signal is generated. This signal is proportional to the logarithm of the ratio of the oxygen concentration in the sample gas to the oxygen concentration in a reference gas contacting the outer electrode. Using the digital panel meter (DPM) the logarithmic signal can be read directly in unlinearized form, or it can be converted to a 0/4–20 mA, 0–2 V, or Namur linearized signal before display.

Note: *A temperature above 650°C is required for proper operation of the oxygen sensor. Also, ambient air is the usual reference gas on the outside of the zirconia sensor.*

The sensor furnace also generates the convective flow that circulates the sample gas through the sample path. Pushed from behind by the hot gases still in the furnace, the hot sample gas in the sensor furnace rises out of the furnace and cools. The cooled sample gases then pass through the outlet port, where they are carried away by the main gas flow.

A platinum coating on the end of the ceramic tube and the zirconia oxygen sensor ensures that all oxidation/reduction reactions in the sample gas reach equilibrium. It is therefore possible to measure such parameters as excess oxygen in air/fuel mixtures and equilibrium oxygen in reducing atmospheres such as hydrogen.

The Zirconia Oxygen Sensor

The inside and outside of the zirconia oxygen sensor are coated with porous platinum, forming two electrodes. The sample gas flows past the inside of the sensor, while atmospheric air circulates freely on the outside of the sensor. This atmospheric air is used as the reference gas for making oxygen measurements. See Figure 1-4 below.

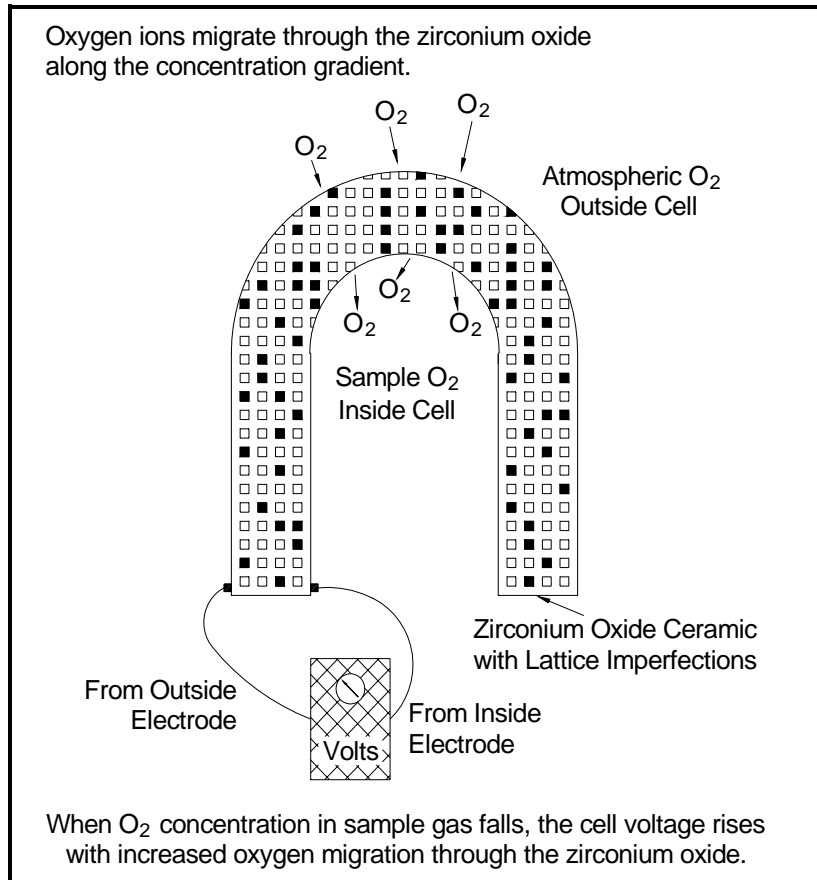

Figure 1-4: Oxygen Migration in the Zirconia Sensor

At the operating temperature of the oxygen sensor, the atmospheric reference oxygen is electrochemically reduced at the outer electrode, and the resulting oxygen ions seek to equalize with the lower oxygen concentration on the sample side of the cell by migrating through the porous ceramic toward the inner electrode. At the inner electrode they give up electrons to become oxygen molecules again, and are swept away by the sample flow.

The lower the concentration of oxygen in the sample gas, the greater the rate of ion migration through the ceramic, and the higher the cell voltage due to electron exchange at the electrodes. The cell voltage rises logarithmically as the amount of oxygen in the sample gas falls, allowing the accurate measurement of very low levels of excess oxygen.

The Heater Control Circuit

The oxygen sensor temperature in the CGA 351 is maintained by a heater, which is part of a complex temperature control loop. This circuit constantly monitors the oxygen sensor temperature, compares it to the set point temperature (700°C), and turns the heater ON or OFF accordingly. The specific type of control circuit, a Proportional Integral Derivative (**PID**) loop, is used because of the adjustable parameters involved:

- **Proportional Band:** Because the system cannot respond instantaneously to temperature changes, the actual temperature of the oxygen sensor oscillates about the set point. In general, increasing the proportional band reduces the magnitude of these temperature oscillations.
- **Integral Action:** A consequence of increasing the proportional band is the introduction of an offset between the set point and the control point. The integral portion of the control loop acts to move the control point back toward the set point within a specified period of time. Decreasing this integration time reduces the offset more quickly.

Note: *A third parameter, Derivative Action, is not used with the CGA 351.*

The heater control circuit is configured at the factory for optimum performance. Because of the strong interaction between the parameters involved, properly setting up the PID loop is a very complex matter. As a result, randomly changing the P, and/or I parameters can seriously degrade the performance of the CGA 351.

IMPORTANT: *Always contact the factory before attempting to change the default P and/or I values. The submenu for performing these changes is password protected to prevent accidental changes.*

Chapter 2

Installation

Introduction.....	2-1
Choosing an Installation Site.....	2-2
Mounting the Model CGA 351	2-3
Wiring the Analyzer.....	2-5

Introduction

This chapter provides a general description of the standard CGA 351 and gives directions on how to install and wire the analyzer for proper operation.

Note: *For information regarding component locations and/or wiring connections in an optional enclosure, see Appendix C.*

IMPORTANT: *For compliance with the European Union's Low Voltage Directive (73/23/EEC), the CGA 351 requires an external power disconnect device such as a switch or circuit breaker. The disconnect device must be marked as such, clearly visible, directly accessible, and located within 1.8 m (6 ft) of the unit.*

!WARNING!

Power up the CGA 351 as quickly as possible after introduction of the sample gas. If the analyzer is left installed without power, the unit's components become susceptible to acid condensation that will cause corrosion.

Be sure to observe all installation limits and precautions described in this chapter. Pay particular attention to the ambient temperature range of -25 to $+50^{\circ}\text{C}$ (-13 to $+122^{\circ}\text{F}$) specified for the instrument.

!WARNING!

To ensure safe operation of the CGA 351, the unit must be installed and operated as described in this manual. Also, be sure to follow all applicable local safety codes and regulations for installing electrical equipment. In addition, all procedures should be performed by trained service personnel.

Choosing an Installation Site

All environmental and installation factors should have been discussed with a GE Infrastructure Sensing applications engineer or field sales person at the time the CGA 351 was ordered. Thus, the equipment should be suited to the application and the planned installation site. Before installing the unit, however, read the following guidelines to verify that the best installation site has been chosen for optimum instrument accuracy and reliability. Make sure that:

- the CGA 351 enclosures are suitable for the environmental conditions at the installation site.
- the analyzer system will be installed in a location with little or no vibration.
- the ambient temperature at the installation site is between -25° and 50°C (-13° and 122°F).
- there are no restrictions in the discharge line (i.e. flow control valves downstream of the meter).
- the CGA 351 system is installed in a location that provides ready access for programming, testing, and servicing the unit.
- the cables will be protected from excessive physical strain (bending, pulling, twisting, etc.). Do not subject the cables to temperatures above 65°C (149°F) or below -50°C (-58°F).
- the line voltage used at the planned installation site corresponds to the factory preset line voltage rating for the meter.

Mounting the Model CGA 351

This section explains how to mount the analyzer components at the installation site and how to connect the sample system to the analyzer.

Note: *If more than one analyzer system is being installed, be aware that each system is a matched set (i.e., each sensor enclosure must be matched to a specific electronics enclosure). Refer to the identification tags on the enclosures to match the systems correctly.*

IMPORTANT: *For compliance with the European Union's Low Voltage Directive (73/23/EEC), the CGA 351 requires an external power disconnect device such as a switch or circuit breaker. The disconnect device must be marked as such, clearly visible, directly accessible, and located within 1.8 m (6 ft) of the unit.*

IMPORTANT: *This symbol indicates Caution - risk of electric shock:*



Refer to Figure 2-1 on page 2-9, and complete the following steps to mount the CGA 351:

1. Select a flat surface on a vertical wall or instrument panel with sufficient space to hold the mounting plate with both of the CGA 351 enclosures.

Note: *Mount the system in an upright position, so that the sample inlet and outlet fittings are on the bottom of the sensor enclosure.*

2. Using the mounting dimensions shown in Figure 2-1 on page 2-9, locate and prepare four (4) mounting holes or two (2) horizontal mounting rails on the vertical surface.
3. Secure the system to the mounting surface with four (4) sets of mounting hardware. Be sure that the enclosures are in a vertical position, with the inlet/outlet connectors on the bottom.
4. The flowmeter, which is fastened to the right side of the sensor enclosure, is connected to the discharge port on the bottom of the unit with a length of 6mm stainless steel tubing. Make sure that the factory-installed Swagelok fittings are secure.
5. A flow control valve is attached to the inlet port on the bottom of the sensor enclosure with 6mm stainless steel tubing and Swagelok fittings. Point the valve in the proper direction to receive the inlet piping from the sample system, and securely tighten the fittings.

Connecting the Sample System

The sample system should be located so that it is able to deliver a sample at a flow rate of $1,000 \pm 150$ cc/min. For best results, mount the sample system as close as possible to the CGA 351. An ideal location would be on the same panel, just below the analyzer. If there are questions, consult with an applications engineer at GE Infrastructure Sensing.

See Figure 2-1 on page 2-9, and complete the following steps to connect the sample system to the analyzer:

1. Using 6mm stainless steel tubing (or 1/4" stainless steel tubing with adaptors), connect the gas source from the sample system to the Swagelok fitting on the flow control valve at the inlet port on the analyzer.
2. Using 6mm stainless steel tubing (or 1/4" stainless steel tubing with adaptors), connect the Swagelok outlet fitting at the top of the flowmeter on the analyzer to the gas discharge connection on the sample system.

Note: *If desired, a suitable sample system may be ordered directly from the factory. The sample system would be supplied fully assembled on a flat plate with four (4) mounting holes.*

Wiring the Analyzer

The system components which are housed in the sensor enclosure have already been wired at the factory. These include:

- oxygen sensor (TB2)
- thermocouple (TB2)
- sensor furnace (TB2)

To completely wire the CGA 351 zirconia oxygen analyzer, the following items must be connected:

- serial port (TB1)
- analog output (TB1)
- alarm relays (TB1)
- line power (TB3)

Refer to the wiring diagram shown in Figure 2-2 on page 2-10, while completing the instructions presented in this section.

!Attention European Customers!
**In order to meet CE Mark requirements, all cables must
installed as described in Appendix B, CE Mark Compliance.**

IMPORTANT: *For compliance with the European Union's Low Voltage Directive (73/23/EEC), the CGA 351 requires an external power disconnect device such as a switch or circuit breaker. The disconnect device must be marked as such, clearly visible, directly accessible, and located within 1.8 m (6 ft) of the unit.*

!WARNING!
**To ensure safe operation of the CGA 351, the unit must be
installed and operated as described in this manual. Also, be
sure to follow all applicable local safety codes and
regulations for installing electrical equipment. In addition,
all procedures should be performed by trained service
personnel.**

To access the terminal printed circuit board, remove the cover below the digital display panel, which is fastened with six (6) Phillips head screws. The PC Board has terminal blocks TB1 (12 connections), TB2 (8 connections), and TB3 (3 connections) mounted on it. Proceed to the appropriate sub-section to wire each of these terminal blocks.

Wiring the Outputs (TB1)

Terminal block TB1 contains connections for the CGA 351's output signals. Specifically, the following signals are available at this terminal block:

- serial port
- 0/4–20 mA, 0–2 V, or Namur analog output
- alarm relays

To wire any or all of these output signals, complete the following steps:

1. Attach a cable or conduit with the appropriate number of conductors to an entry port on the bottom of the electronics enclosure.
2. To connect a serial port from a personal computer, use the *COMM* pins on terminal block TB1 as follows:
 - a. Connect the *transmit* wire to pin 1.
 - b. Connect the *receive* wire to pin 2.
 - c. Connect the *ground/return* wire to pin C.
3. To connect an analog output device, use the *4-20mA* pins on terminal block TB1 as follows:
 - a. Connect the *input* wire to the external device to pin +.
 - b. Connect the *output* wire from the external device to pin –.
4. To connect alarm device(s), use the *ALARM 1* and/or *ALARM 2* pins on terminal block TB1 as follows:
 - a. Connect the *input* wire to the alarm-1 device to pin NO.
 - b. Connect the *output* wire from the alarm-1 device to pin C.
 - c. If desired, repeat sub-steps a and b to connect alarm-2.
5. Connect any shields to pin G.

Proceed to the next section to continue wiring the CGA 351.

Wiring the Inputs (TB2)

Terminal block TB2 contains connections for the CGA 351's sample measurement signals. Specifically, the following signals are routed to this terminal block:

- zirconia oxygen sensor
- thermocouple
- sensor furnace

All of the connections on terminal block TB2 have already been wired at the factory. In the event that one or more of these wires must be reconnected, complete the following steps:

1. Locate the leads from the *zirconia oxygen sensor*. Connect these leads to terminal block TB2 as follows:
 - a. Connect the *positive* sensor wire (white - #1) to pin +.
 - b. Connect the *negative* sensor wire (white - #2) to pin -.
2. Locate the leads from the *thermocouple*. Connect these leads to terminal block TB2 as follows:
 - a. Connect the *positive* thermocouple wire (yellow - no number) to pin +.
 - b. Connect the *negative* thermocouple wire (red - no number) to pin -.

Note: *The two thermocouple wires (red and yellow) are bound together in a brown sheath.*

3. Locate the leads from the *sensor furnace*. Connect these leads to terminal block TB2 as follows:
 - a. Connect one furnace wire (white - #5) to pin 1.
 - b. Connect the other furnace wire (white - #6) to pin 2.

Note: *The polarity of the sensor furnace leads is not important.*

4. Connect the ground wire (white - #G) and any shields to either of the pins labeled G.

This completes the wiring of terminal block TB2. Proceed to the next section to continue wiring the CGA 351.

Wiring the Line Power
(TB3)

Terminal block TB3 contains connections for the line power to the CGA 351. To wire the line power, complete the following steps:

!WARNING!

Before proceeding with the section, verify that the line power has been turned off at the external disconnect device.

1. Attach a cable or conduit with the three line power conductors to an entry port on the bottom of the electronics enclosure.

Caution!

Be sure that the input voltage to the CGA 351 complies with the value specified at the time of purchase. If the voltage is incorrect, contact the factory immediately.

2. Connect the line power leads to terminal block TB3 as follows:
 - a. Connect the *line* power lead (black) to pin L.
 - b. Connect the *neutral* power lead (white) to pin N.
 - c. Connect the *ground* power lead (green) to pin G.

This completes the wiring of the CGA 351 analyzer. Proceed to Chapter 3, *Operation*, for instructions on using the meter.

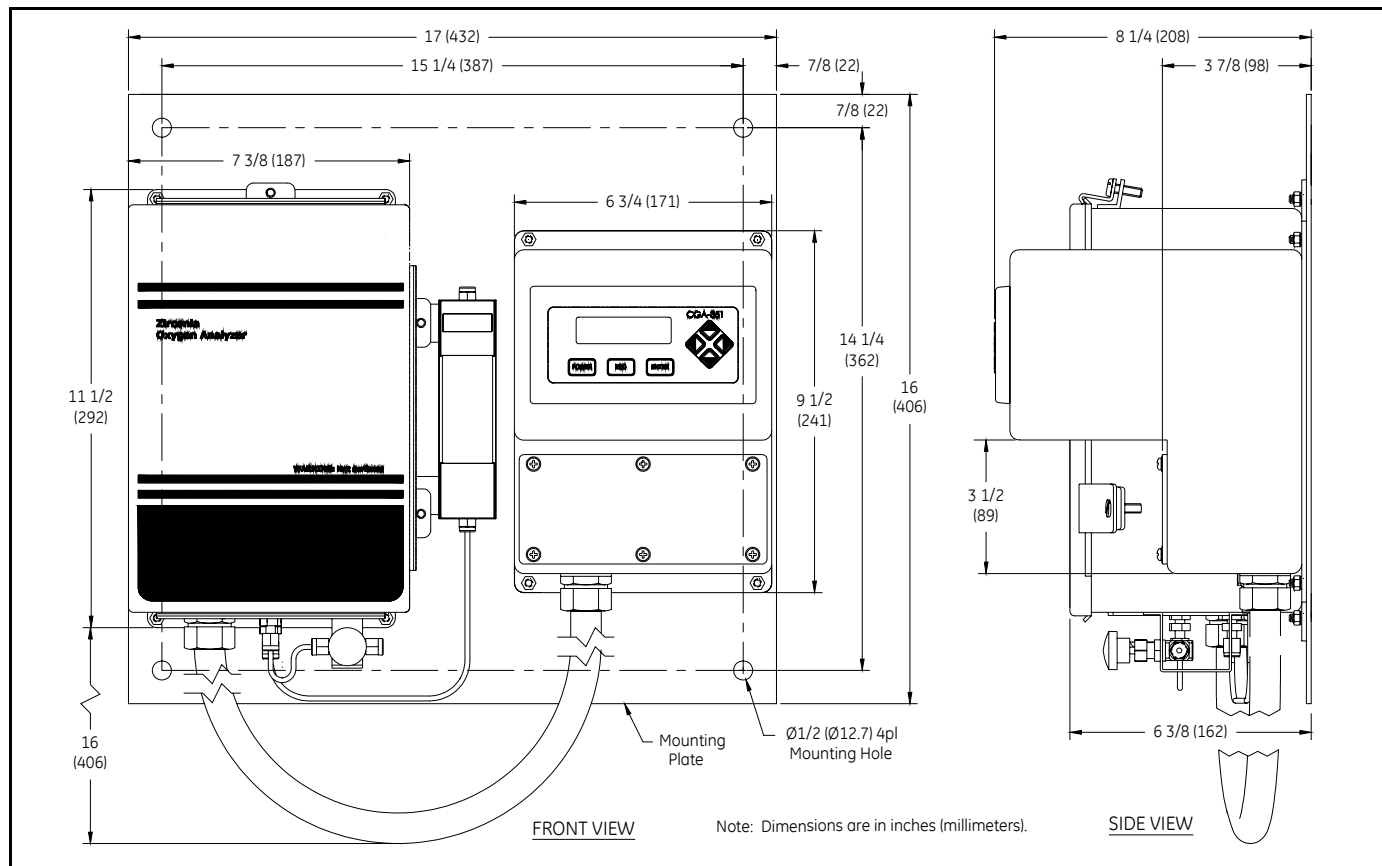

Figure 2-1: Model CGA 351 Mounting Dimensions

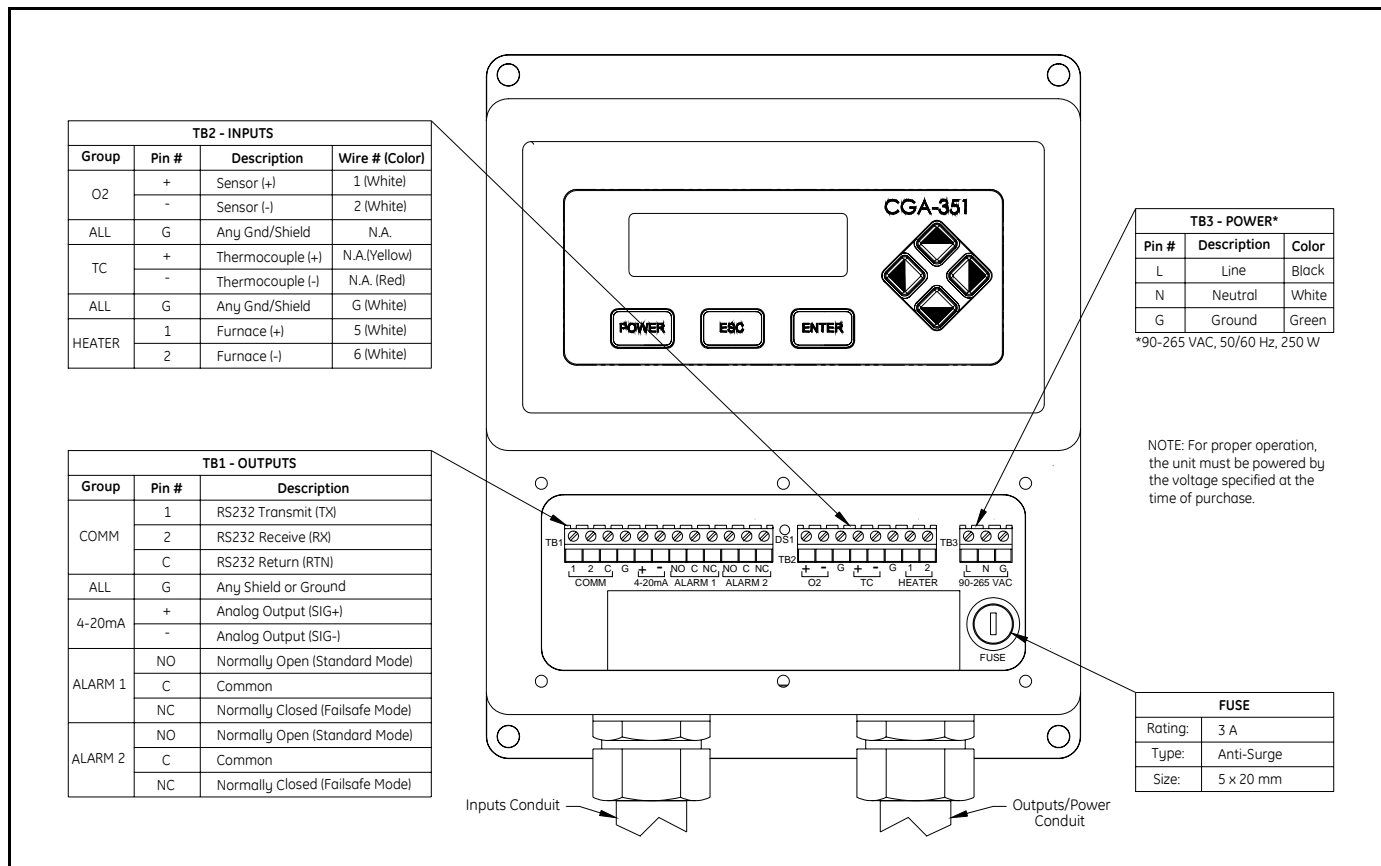

Figure 2-2: Model CGA 351 Wiring Connections

Chapter 3

Operation

Introduction.....	3-1
Preventing Common Problems	3-1
Powering Up the System	3-2
User Program Security	3-2
Configuring the Digital Display	3-3
Converting mV to Oxygen Concentration	3-8
Powering Down.....	3-8

Introduction

The CGA 351 is an easily-operated monitoring device. Before applying power, make sure the system has been installed in accordance with the instructions given in Chapter 2, *Installation*.

Note: *For information regarding component locations and/or wiring connections in an optional enclosure, see Appendix C.*

Allow the unit to warm up for at least thirty minutes prior to use. Check to see if it is hot. Observe all normal safety precautions. Specifically, do not exceed the maximum pressure and temperature ratings of the zirconia oxygen sensor and the sample system.

This chapter includes discussions of the following topics:

- preventing common problems
- powering up the system
- configuring the digital display
- taking measurements

!WARNING!

To ensure safe operation of the CGA 351, it must be installed and operated as described in this manual. In addition, be sure to follow all applicable local safety codes and regulations for installing electrical equipment.

Preventing Common Problems

Use the CGA 351 to accurately measure low oxygen levels. To avoid problems, observe the following:

- Check the calibration of the analyzer once or twice a week for the first month of operation and once every 2–3 months thereafter (see *Calibrating the Model CGA 351* on page 4-31).
- Never use thread sealant on any connection in the sample gas flow path. Thread sealant gives off combustible vapors that can cause reading errors.
- Do not handle the oxygen sensor with bare hands. Although some scratches on the platinum coating can be tolerated, rubbing the coating should be avoided.
- Clean the oxygen sensor only by rinsing it with clean water, after the sensor has cooled. Scrubbing the oxygen sensor or washing a hot sensor in cold water can damage or destroy it.
- Do not disturb the special sealant on the oxygen sensor nut and the inlet fittings. Any leakage in these areas will cause inaccurate readings when measuring low oxygen levels.

Powering Up the System

Before applying power, check the wiring connections and close both enclosures. Energize the external disconnect device to power up the CGA 351. (See page 3-8 for powering down instructions). For reliable readings, allow approximately *two hours* for the analyzer to reach temperature equilibrium before taking measurements.

!WARNING!

To prevent corrosion, the analyzer must be powered up immediately after introduction of the sample gas. If the analyzer is left installed without power, the unit's components become susceptible to acid condensation that will cause corrosion.

If the power must be removed for more than thirty minutes, purge the analyzer through the inlet port with a continuous flow of instrument air at a rate of $1,000 \pm 150$ cc/min (2.1 ± 0.3 SCFH).

IMPORTANT: *For compliance with the European Union's Low Voltage Directive (73/23/EEC), the CGA 351 requires an external power disconnect device such as a switch or circuit breaker. The disconnect device must be marked as such, clearly visible, directly accessible, and located within 1.8 m (6 ft) of the unit.*

User Program Security

The CGA 351 has been equipped with a *User Program* that permits the setup and calibration of the instrument for optimum performance in any specific application. However, to prevent accidental changes to critical system parameters, four levels of security are imposed on the various submenus within the *User Program*. These are:

- *Unlocked* - access to these submenus is gained simply by pressing the [ESC] key. No password is required.
- *Basic (locked)* - access to these submenus is gained by pressing the [ESC], [ENT], and [ESC] keys in sequence. Then, a password must be entered. (The default password is **2719**.)
- *General (locked)* - access to these submenus is gained by pressing the [ESC], [ENT], and [ESC] keys in sequence. Then, a password must be entered.
- *Advanced (locked)* - access to these submenus is gained by pressing the [ESC], [ENT], and [ESC] keys in sequence. Then, a password must be entered.

Note: *The passwords required for the three locked categories mentioned above are all different.*

Configuring the Digital Display

The digital display panel at the top of the electronics enclosure includes the components shown in Figure 3-1 below.

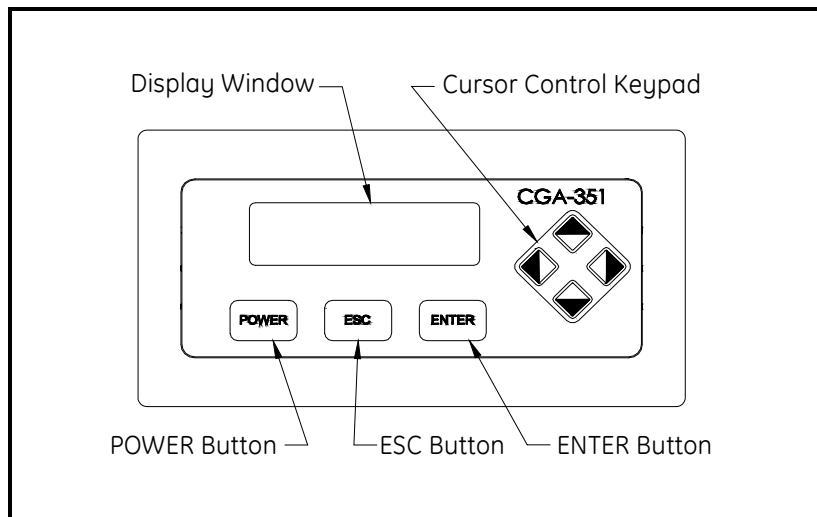
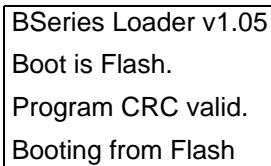

Figure 3-1: Digital Display Panel

A typical display will be configured to the customer's needs at the factory. If changes are required, follow the instructions in this section to complete the initial configuration of the digital display. As an aid in performing this task, refer to the menu map in Figure 3-2 on page 3-9.

Initial Screen Displays

Immediately upon power up, the digital display shows the following sequence of informational screens, as the meter performs its internal systems checks.



BSeries Loader v1.05
Boot is Flash.
Program CRC valid.
Booting from Flash

This is a typical example of the first initialization screen.

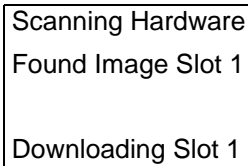

Scanning Hardware
Found Image Slot 1

Downloading Slot 1

This is a typical example of the second initialization screen.

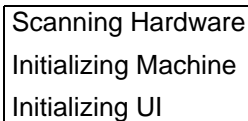

Scanning Hardware
Initializing Machine
Initializing UI

This is a typical example of the final initialization screen.

If the meter passes all of its internal system checks, the following screen appears:

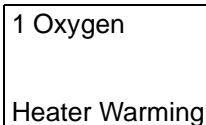

1 Oxygen 

Heater Warming

This is a typical example of an initial screen.

Note: *The padlock icon at the upper right hand corner of the above display indicates that the User Program is locked with password protection.*

Before any data can be displayed, the meter must be configured for the desired display parameter(s). Enter the *User Program* by pressing the [ESC] key and proceed as follows.

IMPORTANT: *In some applications, portions of the User Program may be locked to prevent end user access. If this is the case, entrance to these submenus requires a special key sequence and a password (see page 3-2).*

Configuration Options

Cfg	Cal	Opt	Disp

POWER	ESC	ENTER
-------	-----	-------

Upon entering the *User Program*, the [Cfg] option is already selected. Simply press [ENTER]. (Notice that the [Disp] option is grayed out at this time.

Cfg	Cal	Opt	Disp
1: Cfg			

POWER	ESC	ENTER
-------	-----	-------

To proceed with the [1: Cfg] option, press [ENTER]. To abort the operation, press [ESC].

From 1: Cfg			
Oxygen			
Temperature			
Sensor			

POWER	ESC	ENTER
-------	-----	-------

A list of the available display inputs is shown. Use the [▲] and [▼] keys to select the desired input and press [ENTER]. *Oxygen* has been selected as an example.

Note: *The [CJC Temp] and [Duty Cycle] options are also available in the above list box.*

From 1: Cfg Oxygen			
ppm			
pcnt			

POWER	ESC	ENTER
-------	-----	-------

A list of the available unit types is shown. Use the [▲] and [▼] keys to select the desired units (*parts per million* or *percent*) and press [ENTER].

If either of the *Temperature* inputs is selected for display, °C and °F are available as the unit types. For the *Sensor* and *Duty Cycle* inputs, mV and pcnt, respectively, are the only available unit types.

From 1: Cfg Ox..pcnt			
*0: Display			
*0: Fault Alarm			
Add	Remove	OK	Cancel

POWER	ESC	ENTER
-------	-----	-------

A list of the available output devices is shown. Follow the instructions below to select the desired outputs.

Configuration Options (cont.)

Note: *The [0:Analog Output], [2:Alarm-1], [2:Alarm-2], [2:Alarm-3] and [2:Alarm-4] options are also available in the above box.*

To select the desired output(s) from the previous list box, complete the following steps:

1. Use the [▲] and [▼] keys to highlight a specific output. For this example, make sure that [0: Display] is selected as one of the outputs.
2. Use the [◀] and [▶] keys to select “Add” or “Remove” and press the [ENTER] key to change the status of the selected output. An output is selected if an asterisk (*) appears to its left.
3. When all of the desired outputs have been selected, use the [◀] and [▶] keys to select “OK” and press the [ENTER] key.

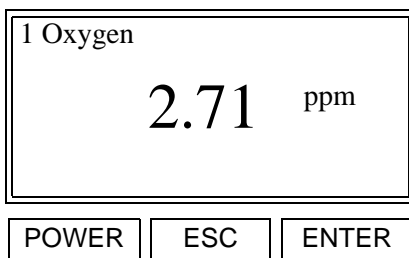

Press [ESC] four times to return the display to the actual set configuration.

Notice that the newly configured display shows the *slot number* and the *input parameter* on the top line, and the current *live value* along with the *unit type* are displayed in the center of the screen.

Note: *See “The [Opt-User] Menu” on page 4-15 for instructions on how to adjust the display contrast.*

Switching Display Windows

After the display has been configured, the meter actually maintains multiple display windows. Although only one window can be displayed at any given time, it is easy to switch to one of the other windows via the *User Program*. Enter the *User Program* by pressing the [ESC] key.

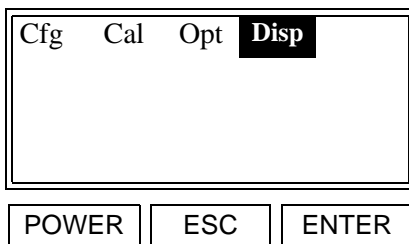

Notice that the fourth option, [Disp], is now available. Use the [◀] and [▶] keys to select [Disp] and press [ENTER].

Switching Display Windows (cont.)

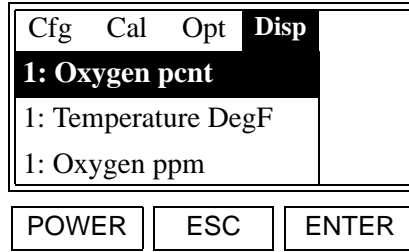

A list of the available windows is shown. Use the [▲] and [▼] keys to select the desired window and press [ENTER].

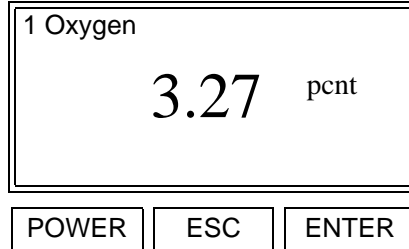

After pressing [ENTER] at the previous prompt, press [ESC] and the alternate display appears.

When configuring the digital display options, the following two factors must be considered:

- Only the *digital display* and the *fault alarm* options can be simultaneously assigned to more than one parameter. This is because they are virtual devices that are stored in memory.
- The *analog output*, *alarm-1*, *alarm-2*, *alarm-3* and *alarm-4* options can be assigned to only one parameter at any given time. This is because they are linked to a specific physical device.

One must be careful about making changes in the *User Program*, while data is being displayed. If the currently selected display input is accidentally deselected, the screen reverts to the following:

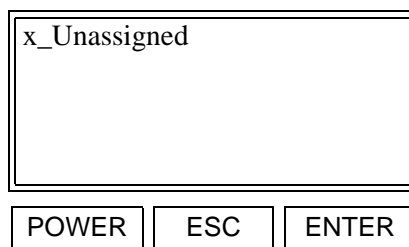

Although the meter is still collecting data, the digital display does not know which information to show. Simply re-select the appropriate input parameter, through the [Disp] menu option, to restore the digital display.

Converting mV to Oxygen Concentration

Although the digital display can show the oxygen concentration in *ppm* or *pcnt* and the oxygen sensor output in *mV*, only one parameter can be displayed at any given time. Therefore, it may sometimes be helpful to manually convert a reading from one form to another. Table 3-1 below provides such information for the full range of the CGA 351, at the typical operating temperature of 700°C.

Table 3-1: Oxygen Reading Conversions

Sensor (mV)	Oxygen (pcnt)	Oxygen (ppm)
-32.8	100	1,000,000
15.4	10	100,000
63.7	1	10,000
111.9	0.1	1,000
160.2	0.01	100
208.4	0.001	10
256.7	0.0001	1
304.9	0.00001	0.1

The data in Table 3-1 above was calculated with the Nernst equation. See Appendix A, *The Nernst Equation*, for details on performing such calculations.

Powering Down

When it becomes necessary to power down the CGA 351 for service, proceed as follows:

1. Press the [POWER] button just below the digital display.
2. Place the external disconnect device into the “OFF” position.

Caution!

Never open the door on the sensor enclosure until the sensor has cooled to ambient temperature (in about two hours). Rapid cooling of a hot sensor will cause cracks in the ceramic sensor.

Any required service procedures may now be performed.

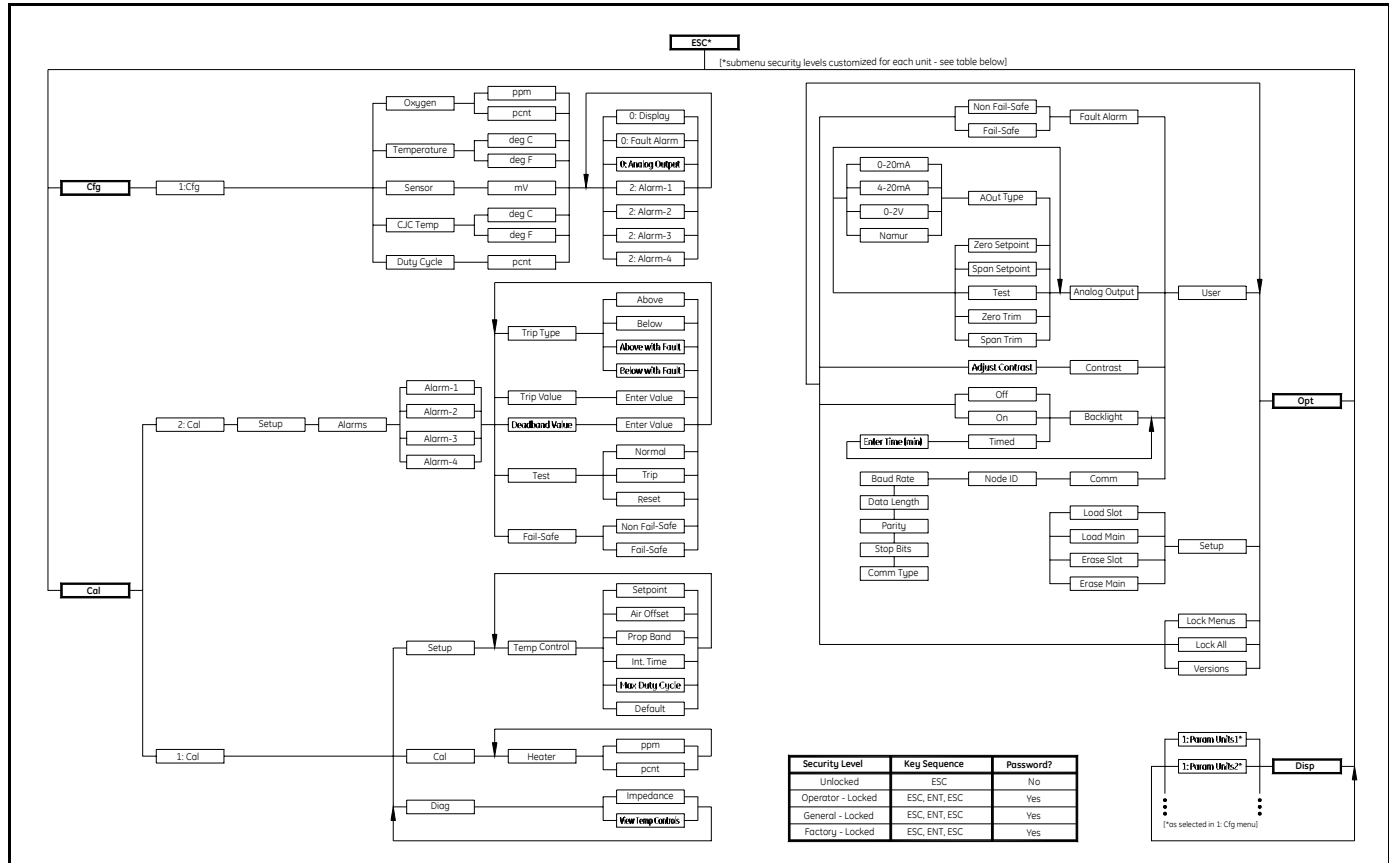

Figure 3-2: CGA 351 Menu Map

Chapter 4

Setup and Calibration

Introduction.....	4-1
Accessing the User Program	4-1
The [Cal] Menu	4-2
Setting Up the Alarm Relays	4-2
Setting the Temperature Controls	4-8
The [Opt-User] Menu	4-15
Setting Fault Alarm Type	4-15
Setting Up the Analog Output.....	4-16
Adjusting the Display Contrast.....	4-24
Setting the Display Backlight	4-25
Setting Up the Serial Port.....	4-26
Setup and Security Settings.....	4-28
Calibrating the Model CGA 351.....	4-31
Checking the Current Settings	4-36

Introduction

Although the CGA 351 is set up at the factory with default operational parameter values that are suitable for many applications, the *User Program* provides a means for customizing many of the setup parameters. Proper setup of the analyzer is very important to ensure accurate data readings.

Generally, changes in calibration result from the aging of the zirconia oxygen sensor. Within limits, oxygen reading errors can usually be compensated for by making minor temperature adjustments. The zirconia oxygen sensor should be calibrated once or twice a week for the first month of operation and every 2–3 months thereafter.

!WARNING!

To ensure safe operation of the CGA 351, it must be installed and operated as described in this manual. In addition, be sure to follow all applicable local safety codes and regulations for installing electrical equipment. In addition, all procedures should be performed by trained service personnel.

Follow the instructions in this chapter exactly to ensure proper setup and calibration of the CGA 351.

Accessing the User Program

To ensure accurate oxygen level readings and to make use of the alarm relays, serial port and analog output, the appropriate entries must be made in the *User Program*. Follow the instructions in this section to accomplish these tasks.

Enter the *User Program* by pressing the [ESC] key. While in the *User Program*, press [ESC] at any time to abort the current operation.

Note: *Some submenus may be locked and will require a special key sequence and a password for entry (see “User Program Security” on page 3-2 of Chapter 3, Operation).*

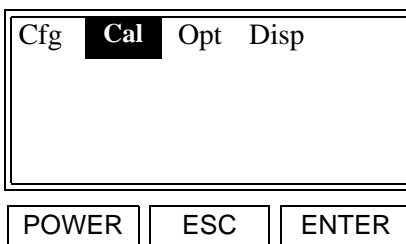

Use the [◀] and [▶] keys to select [Cal] and press [ENTER]. (NOTE: this screen shows the [Disp] option as already being configured.)

As an aid in programming the CGA 351, refer to the menu map, Figure 3-2 on page 3-9. Proceed directly to the appropriate section to set up and/or calibrate the analyzer.

The [Cal] Menu

After entering the *User Program*, access the [Cal] submenu to set the following parameters:

- Alarm-1 relays
- Alarm-2 relays
- Alarm-3 relays
- Alarm-4 relays
- temperature controls

The calibration and diagnostic portions of this submenu are discussed later in this chapter. Proceed to the appropriate section for specific instructions on the topic of interest.

Setting Up the Alarm Relays

To set up the CGA 351's external alarm relays, corresponding to the wiring terminals on TB1, proceed as follows:

Cfg	Cal	Opt	Disp
1: Cal			
2: Cal			

POWER ESC ENTER

Use the [▲] and [▼] keys to select [2: Cal] and press [ENTER].

Setup	
Slct Cal Menu Item	

POWER ESC ENTER

Use the [▲] and [▼] keys to select [Setup] and press [ENTER].

Setup	
Alarms	

POWER ESC ENTER

Use the [▲] and [▼] keys to select [Alarms] and press [ENTER].

Setting Up the Alarm Relays (cont.)

Alarms
Alarm-1
Alarm-2
Alarm-3

POWER	ESC	ENTER
-------	-----	-------

Use the [▲] and [▼] keys to select [Alarm-1] and press [ENTER].

Note: The [Alarm-4] option is also available in the above list box.

The following alarm features may be set in this submenu:

- **Trip Type:** specifies whether the alarm relay triggers when the live measurement value moves *above* or *below* the trip value.
- **Trip Value:** specifies the live measurement value at which the alarm relay triggers.
- **Deadband Value:** specifies a small range of live measurement values, centered on the trip value, for which the alarm relay does not trigger or reset. This prevents the alarm relay from repeatedly triggering and resetting when the live measurement value is very close to the trip value.
- **Test:** permits the manual triggering and resetting of the alarm relay, to verify that it is working properly.
- **Fail-Safe:** specifies whether the alarm relay is energized during normal operation or during an error condition.

Go to the appropriate sub-section to set the desired alarm feature.

Note: The setup of Alarm-1 is used as an example in this manual. To set up Alarm-2, -3 or -4, return to the previous prompt and select the desired option. Then, repeat the following steps.

Setting the Trip Type

Enter the alarm setup menu, as described on page 4-2, and proceed as follows:

Alarms..Alarm-Feat
Trip Type
Trip Value
Deadband Value

POWER	ESC	ENTER
-------	-----	-------

Use the [▲] and [▼] keys to select [Trip Type], and press [ENTER].

Note: The [Test] and [Fail-Safe] options are also available in the above list box.

Setting the Trip Type (cont.)

Alarms A..Trip-Type	
Above	
Below	
Above with Fault	

POWER	ESC	ENTER
-------	-----	-------

Use the [▲] and [▼] keys to select the desired trip type, and press [ENTER].

Note: *The [Below with Fault] option is also available in the above list box.*

The meter now automatically returns to the “Alarm-Features” prompt. Either press [ESC] until you exit the *User Program* or proceed to the appropriate section to continue setting up the alarms.

Setting the Trip Value

Enter the alarm setup menu (see page 4-2) and proceed as follows:

Alarms..Alarm-Feat	
Trip Type	
Trip Value	
Deadband Value	

POWER	ESC	ENTER
-------	-----	-------

Use the [▲] and [▼] keys to select [Trip Value], and press [ENTER].

Note: *The [Test] and [Fail-Safe] options are also available in the above list box*

At the next prompt, enter the desired trip point value.

Alarms..Trip Value	
ppm	
000.00	
s	

POWER	ESC	ENTER
-------	-----	-------

Using the [◀] and [▶] keys, position the cursor under the desired character. Then, use the [▲] and [▼] keys to increment the value. When done, press [ENTER].

The meter now automatically returns to the “Alarm-Features” prompt. Either press [ESC] until you exit the *User Program* or proceed to the appropriate section to continue setting up the alarms.

Setting the Deadband Value

Enter the alarm setup menu (see page 4-2) and proceed as follows:

Alarms..Alarm-Feat	
Trip Type	
Trip Value	
Deadband Value	

POWER	ESC	ENTER
-------	-----	-------

Use the [▲] and [▼] keys to select [Deadband Value], and press [ENTER].

Note: *The [Test] and [Fail-Safe] options are also available in the above list box.*

At the next prompt, enter the desired deadband value.

Alar..Trip-Deadband	
ppm	
000.00	
s	

POWER	ESC	ENTER
-------	-----	-------

Using the [◀] and [▶] keys, position the cursor under the desired character. Then, use the [▲] and [▼] keys to increment the value. When done, press [ENTER].

The meter now automatically returns to the “Alarm-Features” prompt. Either press [ESC] until you exit the *User Program* or proceed to the appropriate section to continue setting up the alarms.

Testing the Alarm Relays

Enter the alarm setup menu, as described on page 4-2. To verify that the alarm relay is functioning properly, the alarm may be operated manually as follows:

Alarms..Alarm-Feat
Trip Value
Deadband Value
Test

POWER	ESC	ENTER
-------	-----	-------

Use the [▲] and [▼] keys to select [Test], and press [ENTER].

Note: *The [Trip Type] and [Fail-Safe] options are also available in the above list box.*

The following options are available in the [TEST] submenu:

- **Normal:** sets the alarm relay to its proper state, as dictated by the current live measurement value.

IMPORTANT: *Always return the alarm relay to this state at the conclusion of the testing.*

- **Trip:** manually triggers the alarm relay to its “ON” state.
- **Reset:** manually returns the alarm relay to its “OFF” state.

Alarms..Alarm-Test
Normal
Trip
Reset

POWER	ESC	ENTER
-------	-----	-------

Use the [▲] and [▼] keys to select the desired TEST option. Press [ENTER] when done.

The meter now automatically returns to the “Alarm-Features” prompt. Either press [ESC] until you exit the *User Program* or proceed to the appropriate section to continue setting up the alarms.

Selecting the Operating Mode

Enter the alarm setup menu, as described on page 4-2, and proceed as follows:

Alarms..Alarm-Feat		
Deadband Value		
Test		
Fail-Safe		

POWER	ESC	ENTER
-------	-----	-------

Use the [▲] and [▼] keys to select [Fail-Safe], and press [ENTER].

Note: *The [Trip Type] and [Trip Value] options are also available in the above list box.*

At the next prompt, enter the desired operating mode.

Note: *In fail-safe mode, the alarm relay is constantly energized during normal operation and is de-energized when the trip point is crossed. In normal (non fail-safe) operation, the alarm relay is energized only when the trip point is crossed.*

Alarms..Fail-Safe		
Non Fail-Safe		
Fail-Safe		

POWER	ESC	ENTER
-------	-----	-------

Use the [▲] and [▼] keys to select the desired operating mode and press [ENTER].

The meter now automatically returns to the “Alarm-Features” prompt. Press [ESC] until you exit the *User Program*.

Setting the Temperature Controls

To configure the temperature control circuits of the CGA 351, complete the following instructions.

Caution!

Improper temperature controls settings can seriously degrade the performance of the instrument.
Never change these settings without specific instructions from GE Infrastructure Sensing.

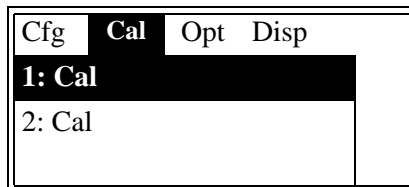

Use the [▲] and [▼] keys to select [1: Cal] and press [ENTER].

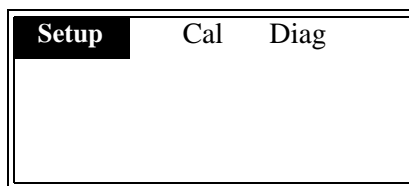
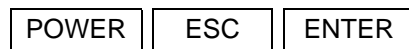

Use the [◀] and [▶] keys to select [Setup] and press [ENTER].

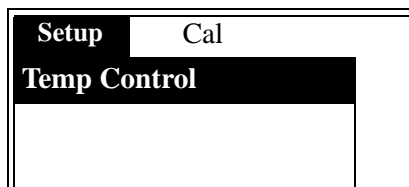
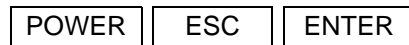

Use the [▲] and [▼] keys to select [Temp Control] and press [ENTER].

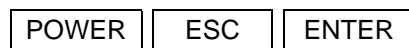

Proceed to the appropriate sub-section to program the desired temperature control feature.

Entering the Setpoint

Read the **CAUTION!** on page 4-8. Enter the temperature control menu as described there and proceed as follows:

Temp-Cntrl
Setpoint
Air Offset
Prop Band

POWER	ESC	ENTER
-------	-----	-------

Use the [▲] and [▼] keys to select [Setpoint] and press [ENTER].

Note: *The [Int Time], [Max.Duty Cycle] and [Defaults] options are also available in the above list box.*

At the next prompt, enter the desired operating temperature for the analyzer. Usually, this is a 700–780°C oxygen sensor temperature.

IMPORTANT: *Calibrating the meter automatically adjusts the value of the setpoint temperature.*

Temp-Cntrl...Set Point
Setpoint
000
s

POWER	ESC	ENTER
-------	-----	-------

Using the [◀] and [▶] keys, position the cursor under the desired character. Then, use the [▲] and [▼] keys to increment the value. When done, press [ENTER].

Temp..Invalid-Output
Modifying value may
cause invalid output
OK Cancel

POWER	ESC	ENTER
-------	-----	-------

This message indicates that changes in this menu will alter the live data output. Press [ENTER] to continue.

Tem..Unit-Measuring
Unit measuring
Accept changes?
Yes No Cancel

POWER	ESC	ENTER
-------	-----	-------

This message indicates that changes in this menu will alter the live data output. To accept the new value, use the [◀] and [▶] keys to select [Yes] and press [ENTER].

The meter now automatically returns to the “Temp. Control” prompt. Either press [ESC] until you exit the *User Program* or proceed to the appropriate section to continue setting up the temperature control.

Setting the Air Offset

Caution!

Improper temperature controls settings can seriously degrade the performance of the instrument.
Never change these settings without specific instructions from GE Infrastructure Sensing.

Enter the temperature control menu, as described on page 4-8, and proceed as follows:

Temp-Cntrl
Setpoint
Air Offset
Prop Band

POWER	ESC	ENTER
-------	-----	-------

Use the [▲] and [▼] keys to select [Air Offset] and press [ENTER].

Note: *The [Int Time], [Max.Duty Cycle] and [Defaults] options are also available in the above list box.*

At the next prompt, enter the desired value for the air offset.

Temp-Cn Air-Offset
Air Offset
000.00
s

POWER	ESC	ENTER
-------	-----	-------

Using the [◀] and [▶] keys, position the cursor under the desired character. Then, use the [▲] and [▼] keys to increment the value. When done, press [ENTER].

Tem..Unit-Measuring
Unit measuring
Accept changes?
Yes No Cancel

POWER	ESC	ENTER
-------	-----	-------

This message indicates that changes in this menu will alter the live data output. To accept the new value, use the [◀] and [▶] keys to select [Yes] and press [ENTER].

The meter now automatically returns to the “Temp. Control” prompt. Either press [ESC] until you exit the *User Program* or proceed to the appropriate section to continue setting up the temperature control.

Setting the Proportional Band

Caution!

Improper temperature controls settings can seriously degrade the performance of the instrument.
Never change these settings without specific instructions from GE Infrastructure Sensing.

Enter the temperature control menu, as described on page 4-8, and proceed as follows:

Note: See page 1-6 for a discussion of the proportional band.

Temp-Cntrl
Setpoint
Air Offset
Prop Band

POWER	ESC	ENTER
-------	-----	-------

Use the [▲] and [▼] keys to select [Prop Band] and press [ENTER].

Note: The [Int Time], [Max.Duty Cycle] and [Defaults] options are also available in the above list box.

At the next prompt, enter the desired value for the proportional band.

Temp-Cntrl Prop
Prop
0000
s

POWER	ESC	ENTER
-------	-----	-------

Using the [◀] and [▶] keys, position the cursor under the desired character. Then, use the [▲] and [▼] keys to increment the value. When done, press [ENTER].

Tem..Unit-Measuring
Unit measuring
Accept changes?
Yes No Cancel

POWER	ESC	ENTER
-------	-----	-------

This message indicates that changes in this menu will alter the live data output. To accept the new value, use the [◀] and [▶] keys to select [Yes] and press [ENTER].

The meter now automatically returns to the “Temp. Control” prompt. Either press [ESC] until you exit the *User Program* or proceed to the appropriate section to continue setting up the temperature control.

Setting the Integration Time

Caution!

Improper temperature controls settings can seriously degrade the performance of the instrument. Never change these settings without specific instructions from GE Infrastructure Sensing.

Enter the temperature control menu, as described on page 4-8, and proceed as follows:

Note: See page 1-6 for a discussion of the integration time.

Temp-Cntrl
Air Offset
Prop Band
Int Time

POWER	ESC	ENTER
-------	-----	-------

Use the [▲] and [▼] keys to select [Int Time] and press [ENTER].

Note: The [Setpoint], [Max.Duty Cycle] and [Defaults] options are also available in the above list box.

At the next prompt, enter the desired value for the integration time.

Temp-Cntrl Int-Time
Int Time
0000
s

POWER	ESC	ENTER
-------	-----	-------

Using the [◀] and [▶] keys, position the cursor under the desired character. Then, use the [▲] and [▼] keys to increment the value. When done, press [ENTER].

Tem..Unit-Measuring
Unit measuring
Accept changes?
Yes No Cancel

POWER	ESC	ENTER
-------	-----	-------

This message indicates that changes in this menu will alter the live data output. To accept the new value, use the [◀] and [▶] keys to select [Yes] and press [ENTER].

The meter now automatically returns to the “Temp. Control” prompt. Either press [ESC] until you exit the *User Program* or proceed to the appropriate section to continue setting up the temperature control.

Setting the Maximum Duty Cycle

Caution!

Improper temperature controls settings can seriously degrade the performance of the instrument. Never change these settings without specific instructions from GE Infrastructure Sensing.

Enter the temperature control menu, as described on page 4-8, and proceed as follows:

Note: *The value selected for this parameter indicates the percentage of time that the heater receives power. Thus, a larger number results in a faster heat up to operating temperature, while a smaller number results in a slower heat up.*

Temp-Cntrl
Prop Band
Int. Time
Max. Duty Cycle

POWER	ESC	ENTER
-------	-----	-------

Use the [▲] and [▼] keys to select [Max. Duty Cycle] and press [ENTER].

Note: *The [Setpoint], [Air Offset] and [Defaults] options are also available in the above list box.*

At the next prompt, enter the desired value for the duty cycle.

Temp-Cn..Duty Cycle
Duty Cycle
000
s

POWER	ESC	ENTER
-------	-----	-------

Using the [◀] and [▶] keys, position the cursor under the desired character. Then, use the [▲] and [▼] keys to increment the value. When done, press [ENTER].

Tem..Unit-Measuring
Unit measuring
Accept changes?
Yes No Cancel

POWER	ESC	ENTER
-------	-----	-------

This message indicates that changes in this menu will alter the live data output. To accept the new value, use the [◀] and [▶] keys to select [Yes] and press [ENTER].

The meter now automatically returns to the “Temp. Control” prompt. Either press [ESC] until you exit the *User Program* or proceed to the appropriate section to continue setting up the temperature control.

Restoring the Default Values

To reset the Setpoint, Proportional Band, Integration Time and Max. Duty Cycle parameters to their default values, enter the temperature control menu, as described on page 4-8, and proceed as follows:

IMPORTANT: *Restoring the default values invalidates the existing calibration. It will be necessary to recalibrate the meter (see “Calibrating the Model CGA 351” on page 4-31) before reliable readings are obtained.*

From Temp Control	
Int. Time	
Max Duty Cycle	
Default	

POWER	ESC	ENTER
-------	-----	-------

Use the [▲] and [▼] keys to select [Default] and press [ENTER].

Note: *The [Setpoint], [Air Offset] and [Prop Band] options are also available in the above list box.*

Tem..Unit-Measuring	
Unit measuring	
Accept changes?	
Yes	No Cancel

POWER	ESC	ENTER
-------	-----	-------

This message indicates that changes in this menu will alter the live data output. To accept the new value, use the [◀] and [▶] keys to select [Yes] and press [ENTER].

The meter now automatically returns to the “Temp. Control” prompt. Press [ESC] until you exit the *User Program*.

The [Opt-User] Menu

After entering the *User Program*, access the [Opt-User] submenu to perform the following operations:

- setting the fault alarm type
- setting up the analog output
- adjusting the display contrast
- setting the display backlight
- configuring the serial port

Proceed to the appropriate section for specific instructions on the topic of interest.

Setting Fault Alarm Type

To set up the fault alarm, enter the *User Program* as described on page 4-1 and proceed as follows:

Cfg	Cal	Opt	Disp
-----	-----	------------	------

Use the [◀] and [▶] keys to select [Opt] and press [ENTER].

POWER	ESC	ENTER
-------	-----	-------

Cfg	Cal	Opt	Disp
User			
Setup			
Lock Menus			

A list of the available options is shown. Use the [▲] and [▼] keys to select [User] and press [ENTER].

POWER	ESC	ENTER
-------	-----	-------

User	
Fault Alarm	
Analog Output	
Contrast	

Use the [▲] and [▼] keys to select [Fault Alarm] and press [ENTER].

POWER	ESC	ENTER
-------	-----	-------

Note: The [Backlight] and [Comm] options are also available in the above list box.

Setting Fault Alarm Type (cont.)

Fault Alarm	
Non Fail-Safe	
Fail-Safe	

POWER	ESC	ENTER
-------	-----	-------

Use the [▲] and [▼] keys to select the desired alarm type and press [ENTER].

The meter now automatically returns to the “User” prompt. Either press [ESC] until you exit the *User Program* or proceed to the appropriate section to continue setting up the user options.

Setting Up the Analog Output

To set up the CGA 351’s analog output, enter the *User Program* (see page 4-1) and proceed as follows:

Cfg	Cal	Opt	Disp
-----	-----	------------	------

POWER	ESC	ENTER
-------	-----	-------

Use the [◀] and [▶] keys to select [Opt] and press [ENTER].

Cfg	Cal	Opt	Disp
User			
Setup			
Lock Menus			

POWER	ESC	ENTER
-------	-----	-------

A list of the available options is shown. Use the [▲] and [▼] keys to select [User] and press [ENTER].

User	
Fault Alarm	
Analog Output	
Contrast	

POWER	ESC	ENTER
-------	-----	-------

Use the [▲] and [▼] keys to select [Analog Output] and press [ENTER].

Note: *The [Backlight] and [Comm] options are also available in the above list box.*

Setting Up the Analog Output (cont.)

The following procedures may be performed in this submenu:

- **Analog Output Type:** configure the analog output for a 0-20 mA, 4-20 mA, 0-2 V, or Namur type.
- **Zero Setpoint:** enter the live measurement value that corresponds to the low end of the analog output range.
- **Span Setpoint:** enter the live measurement value that corresponds to the high end of the analog output range minus the zero setpoint.
- **Test:** specify a fixed percentage of the analog output range and verify that the correct value is generated.
- **Zero Trim:** adjust the actual output to equal the low end of the analog output range.
- **Span Trim:** adjust the actual output to equal the high end of the analog output range minus the zero setpoint.

Proceed to the appropriate sub-section to program the desired analog output feature.

Selecting the Analog Output Type

Enter the analog output setup menu, as described on page 4-16, and proceed as follows:

User Aout
Aout Type
Zero Setpoint
Span Setpoint

POWER	ESC	ENTER
-------	-----	-------

Use the [▲] and [▼] keys to select [Aout Type], and press [ENTER].

Note: *The [Test], [Zero Trim] and [Span Trim] options are also available in the above list box.*

User Aout Aout-Type
0-20mA
4-20mA
0-2V

POWER	ESC	ENTER
-------	-----	-------

Use the [▲] and [▼] keys to select the desired device type, and press [ENTER].

Note: *The [0-2V] option is software-selected and therefore there is no need for hardware modifications to output 0-2 volts DC.*

Note: *The [Namur] option is also available in the above list box.*

Note: *The Namur NE43 specification requires a 4-20 mA output to be clamped in specific bands to indicate out-of-range errors.*

Note: *The 0-2V option is software-selected and therefore there is no need for hardware modifications to output 0-2 volts DC.*

The meter now automatically returns to the “Analog Output” prompt. Either press [ESC] until you exit the *User Program* or proceed to the appropriate section to continue setting up the analog output.

Setting the Zero Setpoint

Enter the analog output setup menu, as described on page 4-16, and proceed as follows:

User Aout
Aout Type
Zero Setpoint
Span Setpoint

POWER	ESC	ENTER
-------	-----	-------

Use the [▲] and [▼] keys to select [Zero Setpoint], and press [ENTER]

Note: *The [Test], [Zero Trim] and [Span Trim] options are also available in the above list box.*

At the next prompt, enter the desired zero setpoint.

User Aout Zero-Set
ppm
000.00
\$

POWER	ESC	ENTER
-------	-----	-------

Use [◀] and [▶] to position the cursor under the desired character. Then, use [▲] and [▼] to increment the value. Press [ENTER] when done.

The meter now automatically returns to the “Analog Output” prompt. Either press [ESC] until you exit the *User Program* or proceed to the appropriate section to continue setting up the analog output.

Setting the Span Setpoint Enter the analog output setup menu, as described on page 4-16, and proceed as follows:

User Aout
Aout Type
Zero Setpoint
Span Setpoint

POWER	ESC	ENTER
-------	-----	-------

Use the [▲] and [▼] keys to select [Span Setpoint], and press [ENTER].

Note: *The [Test], [Zero Trim] and [Span Trim] options are also available in the above list box.*

At the next prompt, enter the desired span setpoint.

User Aout Span-Set
ppm
000.00
s

POWER	ESC	ENTER
-------	-----	-------

Use [◀] and [▶] to position the cursor under the desired character. Then, use [▲] and [▼] to increment the value. Press [ENTER] when done.

The meter now automatically returns to the “Analog Output” prompt. Either press [ESC] until you exit the *User Program* or proceed to the appropriate section to continue setting up the analog output.

Testing the Analog Output Enter the analog output setup menu, as described on page 4-16, and proceed as follows:

User Aout
Zero Setpoint
Span Setpoint
Test

POWER	ESC	ENTER
-------	-----	-------

Use the [▲] and [▼] keys to select [Test], and press [ENTER].

Note: *The [Aout Type], [Zero Trim] and [Span Trim] options are also available in the above list box.*

At the next prompt, enter the desired “Test Percent” value, which is the analog output value (expressed as a percent of the analog output span) used by the meter as a TEST signal.

User Aout Aout-Test
Test Percent
0 t

POWER	ESC	ENTER
-------	-----	-------

Use [▲] and [▼] to increment the value. Press [ENTER] when done.

The meter now automatically returns to the “Analog Output” prompt. Either press [ESC] until you exit the *User Program* or proceed to the appropriate section to continue setting up the analog output.

Setting the Zero Trim

Using the procedure under “Testing the Analog Output” on page 4-21, set the *Test Percent* to 0.

At the analog output setup menu, proceed as follows:

User Aout
Span Setpoint
Test
Zero Trim

POWER	ESC	ENTER
-------	-----	-------

Use the [▲] and [▼] keys to select [Zero Trim], and press [ENTER].

Note: *The [Aout Type], [Zero Setpoint] and [Span Trim] options are also available in the above list box.*

At the next prompt, enter the desired value for the zero trim.

User Aout Zero-Trim
Zero Trim
s
0 t

POWER	ESC	ENTER
-------	-----	-------

Use [▲] and [▼] to increment the value. Press [ENTER] when done.

The meter now automatically returns to the “Analog Output” prompt.

Using the procedure under “Testing the Analog Output” on page 4-21, reset the *Test Percent* to its normal value.

Either press [ESC] until you exit the *User Program* or proceed to the appropriate section to continue setting up the analog output.

Setting the Span Trim

Using the procedure under “Testing the Analog Output” on page 4-21, set the *Test Percent* to 100.

At the analog output setup menu, proceed as follows:

User Aout
Test
Zero Trim
Span Trim

POWER	ESC	ENTER
-------	-----	-------

Use the [▲] and [▼] keys to select [Span Trim], and press [ENTER].

Note: *The [Aout Type], [Zero Setpoint] and [Span Setpoint] options are also available in the above list box.*

At the next prompt, enter the desired value for the span trim.

User Aout Span-Trim
Span Trim
s
0 t

POWER	ESC	ENTER
-------	-----	-------

Use [▲] and [▼] to increment the value. Press [ENTER] when done.

The meter now automatically returns to the “Analog Output” prompt.

Using the procedure under “Testing the Analog Output” on page 4-21, reset the *Test Percent* to its normal value.

Either press [ESC] until you exit the *User Program* or proceed to the appropriate section to continue setting up the analog output.

Adjusting the Display Contrast

To adjust the contrast of the LCD display, enter the *User Program*, as described on page 4-1, and proceed as follows:

Cfg	Cal	Opt	Disp
-----	-----	------------	------

POWER	ESC	ENTER
-------	-----	-------

Use the [◀] and [▶] keys to select [Opt] and press [ENTER].

Cfg	Cal	Opt	Disp
User			
Setup			
Lock Menus			

POWER	ESC	ENTER
-------	-----	-------

A list of the available options is shown. Use the [▲] and [▼] keys to select [User] and press [ENTER].

Note: The [Lock All] and [Versions] options are also available in the above list box.

Cfg	Cal	Opt	Disp
Fault Alarm			
Analog Output			
Contrast			

POWER	ESC	ENTER
-------	-----	-------

A list of the available options is shown. Use the [▲] and [▼] keys to select [Contrast] and press [ENTER].

Note: The [Backlight] and [Comm] options are also available in the above list box.

User Adjust-Contrast	
Adjust Contrast	
s	
0	t

POWER	ESC	ENTER
-------	-----	-------

Use the [▲] and [▼] keys to increment the value to a number between 35 (min. contrast) and 50 (max. contrast). When done, press [ENTER].

The meter now automatically returns to the “User” prompt. This completes the adjusting of the display contrast. Either press [ESC] until you exit the *User Program* or proceed to the appropriate section of this chapter to continue programming the analyzer.

Setting the Display Backlight

To set the LCD display backlight, enter the *User Program*, as described on page 4-1, and proceed as follows:

Cfg	Cal	Opt	Disp
User			
Setup			
Lock Menu			

POWER ESC ENTER

Use the [◀] and [▶] keys to select [Opt]. Then, Use the [▲] and [▼] keys to select [User] and press [ENTER].

Note: The [Lock All] and [Versions] options are also available in the above list box.

User
Analog Output
Contrast
Backlight

POWER ESC ENTER

Use the [▲] and [▼] keys to select [Backlight] and press [ENTER].

Note: The [Fault Alarm] and [Comm] options are also available in the above list box.

User Backlight
Off
On
Timed

POWER ESC ENTER

Use the [▲] and [▼] keys to select the desired option and press [ENTER].

Note: If [Off] or [On] was selected, the following prompt does not appear. If [Timed] was selected, enter a value below for the length of time without keypad activity that the backlight will be turned "Off" until further keypad activity is detected.

User Backlight Timed
Minutes
00
s

POWER ESC ENTER

Use [◀] and [▶] to position the cursor under each character. Use [▲] and [▼] to increment the value of each so the total number is between 00 and 99. When done, press [ENTER].

This completes the adjusting of the display backlight. Either press [ESC] until you exit the *User Program* or continue programming.

Setting Up the Serial Port To set up the serial port, enter the *User Program*, as described on page 4-1, and proceed as follows:

Cfg	Cal	Opt	Disp
User			
Setup			
Lock Menus			

POWER ESC ENTER

Use the [◀] and [▶] keys to select [Opt]. Then, Use the [▲] and [▼] keys to select [User] and press [ENTER].

Note: The [Lock All] and [Versions] options are also available.

User
Contrast
Backlight
Comm

POWER ESC ENTER

Use the [▲] and [▼] keys to select [Comm] and press [ENTER].

Note: The [Fault Alarm] and [Analog Output] options are also available in this list box.

Entering the Node ID

At the following prompt, choose one of the following numbers as the Node ID: 16, 32, 48, 64, 80, 96, 112, 128, 144, 160, 176, 192, 208, 224, or 240.

User Node-ID
Node ID
s
16 t

POWER ESC ENTER

Use the [▲] and [▼] keys to scroll the list of available node ID numbers. When the desired number is highlighted, press [ENTER].

Entering the Baud Rate

At the following prompt, choose one of the following values as the serial port baud rate: 300, 1200, 2400, 9600, 19200, 38400, 57600, or 115200.

User Node..Baud-Rate
300
1200
2400

POWER ESC ENTER

Use the [▲] and [▼] keys to scroll the list of available baud rates. When the desired rate is highlighted, press [ENTER].

Entering the Number of Data Bits

At the following prompt, enter the number of data bits in each data string.

Node I..Data-Length	
7	
8	

POWER	ESC	ENTER
-------	-----	-------

Use the [▲] and [▼] keys to select the desired data length and press [ENTER].

Entering the Parity

At the following prompt, enter the parity setting.

Node-ID Bau..Parity	
None	
Odd	
Even	

POWER	ESC	ENTER
-------	-----	-------

Use the [▲] and [▼] keys to select the parity setting and press [ENTER].

Entering the Number of Stop Bits

At the following prompt, enter the number of stop bits in each data string.

Node-ID..Stop-Bits	
1	
2	

POWER	ESC	ENTER
-------	-----	-------

Use the [▲] and [▼] keys to select desired number of stop bits and press [ENTER].

Selecting the Type of Serial Port

At the following prompt, enter the type of serial port desired.

Node-ID..Comm-Type	
RS-232	
RS-485	

POWER	ESC	ENTER
-------	-----	-------

Use the [▲] and [▼] keys to select type of serial port and press [ENTER].

The meter now automatically returns to the “Node-ID..Stop-Bits” prompt . This completes the setting of the serial port. Either press [ESC] until you exit the *User Program* or proceed to the appropriate section of this chapter to continue programming the meter.

IMPORTANT: *Check to make sure the communication parameters selected match the settings on the computer.*

Setup and Security Settings

After entering the *User Program*, access the [Opt] submenu to perform the following operations:

- setting up the option card slots
- setting the security levels

Proceed to the appropriate section for specific instructions on the topic of interest.

Setting Up the Option Card Slots

To set up the option card slots, enter the *User Program* as described on page 4-1 and proceed as follows:

Cfg	Cal	Opt	Disp
-----	-----	------------	------

POWER	ESC	ENTER
-------	-----	-------

Use the [◀] and [▶] keys to select [Opt] and press [ENTER].

Cfg	Cal	Opt	Disp
User			
Setup			
Lock Menus			

POWER	ESC	ENTER
-------	-----	-------

Use the [▲] and [▼] keys to select [Setup] and press [ENTER].

Note: *The [Lock All] and [Versions] options also appear in the above list box.*

At the following prompt, an option card may be added or removed in an expansion slot, or options may be added or removed in the main (slot 0) position.

Setup	
Load Slot	
Load Main	
Erase Slot	

POWER	ESC	ENTER
-------	-----	-------

Use the [▲] and [▼] keys to select the desired action and press [ENTER].

Note: *The [Erase Main] option is also available in the above list box.*

Setting Up the Option Card Slots (cont.)

Setup Load-Slot	
1: Load	
2: Load	

POWER	ESC	ENTER
-------	-----	-------

Use the [▲] and [▼] keys to select the desired slot designation and press [ENTER].

ID:
Size:
Received Block:
Write to Slot 1

POWER	ESC	ENTER
-------	-----	-------

Using a personal computer, enter the appropriate information.

This completes the setting up of the option card slot. To exit the *User Program*, disconnect and reconnect power to system. Follow the same procedure to add or remove additional option cards.

Caution!

Be careful when using *Erase Slot* or *Erase Main* to make sure the information is no longer needed.

Setting the Security Levels To set up the menu security levels, enter the *User Program* as described on page 4-1 and proceed as follows:

Cfg	Cal	Opt	Disp

POWER	ESC	ENTER
-------	-----	-------

Use the [◀] and [▶] keys to select [Opt] and press [ENTER].

Cfg	Cal	Opt	Disp
Lock Menus			
Lock All			
Versions			

POWER	ESC	ENTER
-------	-----	-------

Use the [▲] and [▼] keys to select the desired option and press [ENTER].

Note: *The [User] and [Setup] options also appear in the above list box.*

Because these menus are intended for factory use only, specific programming instructions are not presented here. However, the general purposes of these menus are as follows:

- **Lock Menus:** this option permits the setting of the security level for any of the individual submenus.
- **Lock All:** this option institutes password protection for all submenus simultaneously.
- **Versions:** this option displays the software versions for each of the system components.

After responding to any of the above options, the meter now automatically returns to the “Opt” prompt. This completes the setting of the option slots and the security levels. Either press [ESC] until you exit the *User Program* or proceed to the appropriate section of this chapter to continue programming the meter.

Calibrating the Model CGA 351

To calibrate the CGA 351 analyzer, the following steps must be completed:

- introduce the chosen calibration gas
- regulate the calibration gas flow rate
- adjust the calibration setting as required

Proceed with the instructions in this section to calibrate the analyzer.

Recommended Calibration Gas

To properly calibrate the zirconia oxygen sensor, a calibration gas of known composition must be used. The following calibration gas is recommended by GE Infrastructure Sensing:

- 5 ppm O₂ in N₂

IMPORTANT: *The gas cylinder must be certified as to the exact composition of the calibration gas.*

A calibration gas containing only CO is not recommended, since the analyzer will not respond correctly to dry calibration gases that do not contain H₂. However, CO may be used if moisture is added to the gas by passing it through a saturator or bubbler.

Uncertainty in the oxygen content of the calibration gas may be a significant source of error in the calibration process. A standard certificate of analysis has an uncertainty in the smaller component of $\pm 5\%$. For the recommended calibration gas, this means an oxygen range of 4.5–5.5 ppm, and the corresponding potential calibration errors shown in Table 4-1 below are introduced.

Table 4-1: Calibration Uncertainty

ppm O ₂	T(°C)	mV	Δ mV	%Error
4.5	700	225.317	+2.209	+0.99
5.0		223.108	0.00	0.00
5.5		221.110	-1.03	-0.90

As shown in Table 4-1 above, a calibration uncertainty of about $\pm 0.95\%$ is introduced by the calibration gas uncertainty alone.

Regulating the Calibration Gas Flow Rate

A temporary connection may be made for calibration purposes. However, if a permanent connection is preferred, it should be as short as possible with an isolation valve right at the calibration gas inlet on the analyzer. See the typical sample system in Figure 1-3 on page 1-3 for an acceptable arrangement.

Each CGA 351 is tagged with its optimum calibration gas flow rate, based on the testing performed during its factory calibration. Typically, this value will be $1,000 \pm 150$ cc/min (2.1 ± 0.3 SCFH).

To set up for calibration complete the following steps:

1. Begin the flow of calibration gas to the inlet port of the analyzer, at atmospheric pressure.
2. Using the flowmeter and needle valve supplied with the analyzer, set the calibration gas flow rate to the tagged value.
3. Set the digital display to show the oxygen concentration in ppm (see “Configuring the Digital Display” on page 3-3). At the standard operating temperature of 700°C, an oxygen level of 5 ppm corresponds to a raw sensor output of 223.108 mV.

Note: *Air calibration at 20.9% O₂ / 0.0 mV is performed during the factory setup. Field recalibration of this zero mV point is seldom required.*

Note: *For other temperature and/or oxygen values see Appendix A, The Nernst Equation, for the expected mV output reading.*

If the analyzer does not respond correctly at the tagged calibration gas flow rate (i.e. the oxygen concentration reading is more than 5% in error), the problem is probably due to improper siting of the unit. Contact the factory for assistance.

Caution!

Make sure the calibration gas flow rate does not exceed 1,200 cc/min (2.5 SCFH). Higher flow rates may cool the oxygen sensor below the normal operating temperature and affect the accuracy of measurements or even cause damage to the oxygen sensor.

The oxygen concentration reading in ppm should correspond to the certified oxygen content of the calibration gas $\pm 5\%$. If the correct ppm reading is not obtained with the calibration gas, proceed to the next section to adjust the calibration setting.

Adjusting the Calibration Setting

After the calibration gas flow to the CGA 351 has been established, as described in the previous sections, the calibration gas setting may be adjusted as necessary. To adjust the heater setting, complete the following steps:

1. Verify that the calibration gas flowing through the analyzer meets the requirements for oxygen content (5 ppm), flow rate ($1,000 \pm 150$ cc/min) and pressure (1 Atm).
2. Make sure that the digital display is configured to read the oxygen concentration in ppm.

Note: *The oxygen sensor calibration is actually accomplished by adjusting its operating temperature until the required mV output is achieved.*

3. Adjust the heater setting as follows:

1 Oxygen		
5.05 ppm		
POWER	ESC	ENTER

Press [ESC] to access the *User Program*. (The value shown indicates a +1.0% calibration error.)

Note: *While in the User Program, press [ESC] at any time to abort the current operation.*

Cfg	Cal	Opt	Disp
POWER	ESC	ENTER	

Use the [◀] and [▶] keys to select [Cal] and press [ENTER].

Cfg	Cal	Opt	Disp
1: Cal			
2: Cal			
POWER	ESC	ENTER	

A list of the slots available for calibration is shown. Use the [▲] and [▼] keys to select [1: Cal] and press [ENTER].

Adjusting the Calibration Setting (cont.)

Setup	Cal	Diag
Slct Cal Menu Item		

POWER ESC ENTER

Use the [◀] and [▶] keys to select [Cal] and press [ENTER].

Setup	Cal	Diag
Heater		

POWER ESC ENTER

Use the [▲] and [▼] keys to select [Heater] and press [ENTER].

PPM-Percent	
PPM	
Percent	

POWER ESC ENTER

Use the [▲] and [▼] keys to select [PPM] and press [ENTER].

At the next prompt, enter the correct value for the oxygen concentration in ppm. If desired, refer to Appendix A, *The Nernst Equation*, to determine the corresponding sensor output in mV.

PPM-Percent	PPM
PPM	
000.00	
s	

POWER ESC ENTER

Using the [◀] and [▶] keys, position the cursor under the desired character. Then, use the [▲] and [▼] keys to increment the value. When done, press [ENTER].

PPM.. Invalid Output	
Modifying value may cause invalid output	
Yes	No

POWER ESC ENTER

Use the [◀] and [▶] keys to select [Yes] and press [ENTER].

Adjusting the Calibration Setting (cont.)

PPM-Percent..Cal-Gas		
Start the Calibration Gas		
Back	Next	Cancel

POWER	ESC	ENTER
-------	-----	-------

When ready, use the [◀] and [▶] keys to select [Next] and press [ENTER].

PPM-Per..Cal-Heater		
Calibrating Heater		
S=xxx T=xxx.x D=xx.x		
Back	Cancel	

POWER	ESC	ENTER
-------	-----	-------

This message appears until the calibration adjustment has been completed (usually about 15–30 minutes).

Calibrating Complete		
Select Finish		
Back	Finish	

POWER	ESC	ENTER
-------	-----	-------

If the calibration passed, use the [◀] and [▶] keys to select [Finish] and press [ENTER].

1 Oxygen		
5.00 ppm		

POWER	ESC	ENTER
-------	-----	-------

The value shown is now the correct ppm value for the oxygen content of the calibration gas.

Note: *If the calibration “Failed”, repeat the calibration procedure. If another failure occurs, contact the factory for assistance.*

4. Discontinue the flow of calibration gas to the analyzer.
5. Resume the flow of process gas to the analyzer.
6. If necessary, reconfigure the digital display to show the desired process parameter.

The CGA 351 may now be placed back into service.

Checking the Current Settings

To aid in monitoring the operation of the CGA 351, a built-in diagnostics routine is included in the *User Program*. To access this submenu, proceed as follows:

1 Oxygen
2.71 ppm

POWER	ESC	ENTER
-------	-----	-------

Press [ESC] to access the *User Program* (see page 4-1).

Note: While in the User Program, press [ESC] at any time to abort the current operation.

Cfg	Cal	Opt	Disp
-----	------------	-----	------

POWER	ESC	ENTER
-------	-----	-------

Use the [◀] and [▶] keys to select [Cal] and press [ENTER].

Cfg	Cal	Opt	Disp
1: Cal			
2: Cal			

POWER	ESC	ENTER
-------	-----	-------

A list of the slots available for calibration is shown. Use the [▲] and [▼] keys to select [1: Cal] and press [ENTER].

Setup	Cal	Diag
Slct Cal Menu Item		

POWER	ESC	ENTER
-------	-----	-------

Use the [◀] and [▶] keys to select [Diag] and press [ENTER].

Checking the Sensor Impedance

Enter the [Diag] as described on page 4-36, and proceed as follows:

Setup	Cal	Diag
Impedance		
View Temp Controls		

POWER	ESC	ENTER
-------	-----	-------

Use the [▲] and [▼] keys to select [Impedance] and press [ENTER].

Sensor-Impedance
Impedance xxx.xx
OK

POWER	ESC	ENTER
-------	-----	-------

The oxygen sensor impedance, in ohms, is shown. Press [ENTER] to continue.

The meter now automatically returns to the “1:Cal” prompt . This completes the checking of the sensor impedance. Either press [ESC] until you exit the *User Program* or proceed to the next section of this chapter to continue checking the settings.

Viewing the Heater Settings

Enter the [Diag] as described on page 4-36, and proceed as follows:

Setup	Cal	Diag
Impedance		
View Temp Controls		

POWER	ESC	ENTER
-------	-----	-------

Use the [▲] and [▼] keys to select [View Temp Controls] and press [ENTER].

View Temp Controls
SetP Prop IntT Duty
xxx xxxx xxxx xxx
OK

POWER	ESC	ENTER
-------	-----	-------

The current temperature control settings are shown. Press [ENTER] to continue.

Note: *The four values shown above represent the current setpoint, proportional band, integration time, and maximum duty cycle.*

The meter now automatically returns to the “Diag” prompt . This completes the viewing of the heater settings. Press [ESC] until you exit the *User Program*.

Chapter 5

Service and Maintenance

Introduction.....	5-1
General Troubleshooting	5-1
Calibration Responses	5-11
Parts Replacement.....	5-12
Recommended Spare Parts	5-24

Introduction

The CGA 351 has been designed to provide years of trouble-free operation. However, because of the technical challenges involved in measuring very low levels of oxygen, some difficulties may occasionally be encountered. The procedures for resolving many of these situations are discussed in this chapter. If the information provided in this chapter is insufficient to solve the problem, please contact the factory for further assistance.

If a faulty component is discovered in the CGA 351, that component is usually replaceable on site. Contact the factory to obtain a new part, and proceed to the appropriate section of this chapter for installation instructions.

!WARNING!

To ensure safe operation of the CGA 351, it must be installed and operated as described in this manual. In addition, be sure to follow all applicable local safety codes and regulations for installing electrical equipment. In addition, all procedures should be performed by trained service personnel.

General Troubleshooting

This section discusses the following general categories of problems that may arise with the CGA 351:

- faulty wiring
- a faulty thermocouple
- a faulty oxygen sensor
- a faulty sensor furnace
- missing sensor furnace voltage

Use this section to troubleshoot any malfunction in the CGA 351. Refer to Figure 5-2 on page 5-25, and complete the following sections in the sequence indicated.

Note: *For information regarding component locations and/or wiring connections in an optional enclosure, see Appendix C.*

Checking the Wiring

Complete the two checks listed below to correct any wiring problems.

!WARNING!

Be careful when tightening the terminal block electrical connections. Full line voltage is present on some terminals.

IMPORTANT: *These symbols indicate Caution - dangerously hot surfaces and risk of electric shock, respectively:*



1. Open the cover on the sensor enclosure and remove the lower front panel from the electronics enclosure.

Note: *For information regarding component locations and/or wiring connections in an optional enclosure, see Appendix C.*

2. Check all wiring, including that performed at the factory. Refer to the wiring instructions in Chapter 2, *Installation*, and the wiring diagram in Figure 2-2 on page 2-10, to make sure that all wires are attached to the correct pins. If any connections are loose, turn the screws clockwise with a small screwdriver to secure the connections.

3. Locate the oxygen sensor clips (see Figure 5-2 on page 5-25) and short them together with a jumper. The oxygen display should read 20.93%.

Note: *Due to an uncorrected offset in some units, an exact reading of 20.93% may not be obtained. However, the result should be close to this value.*

4. If the wiring is good and a 20.93% oxygen reading is obtained with the shorted clips, **remove the jumper**, and proceed to the next section.

Note: *If an open loop (OL) is measured at the oxygen sensor clips, recheck the wiring and try again. If the OL reading repeats, contact the factory for assistance.*

Note: *A cold sensor will always indicate an open loop (OL).*

Checking the Thermocouple

To check the thermocouple temperature sensor used in the CGA 351, complete the following steps:

!WARNING!

There are very hot surfaces in the sensor enclosure. Touching any of these surfaces without heat resistant gloves will result in serious burns.

Note: *For information regarding component locations and/or wiring connections in an optional enclosure, see Appendix C.*

1. Locate the thermocouple (TC) leads on pin + (yellow - no number) and pin - (red - no number) on terminal block TB2.
2. Using a digital multimeter, measure the voltage across the TC terminals. One of the conditions listed in Table 5-1 below should occur.

Table 5-1: TC Voltage Reading at 700°C

Voltage Reading	Recommended Action
25-31 mV	The temperature is good - proceed to the oxygen sensor check on page 5-5.
<25 mV	The temperature is low - proceed to the sensor furnace check on page 5-5.
0 mV reading	The TC is defective - proceed to the TC replacement instructions on page 5-17.

3. Complete the action recommended in Table 5-1 above.

Note: *If a voltage reading other than those listed above is obtained, refer to Figure 5-1 and/or Table 5-2 on page 5-4 to determine the operating temperature of the sensor furnace. A standard CGA 351 operates at a temperature of 700°C.*

Based on the recommended action in Table 5-1 above, proceed to the appropriate section for further instructions.

Checking the
Thermocouple (cont.)

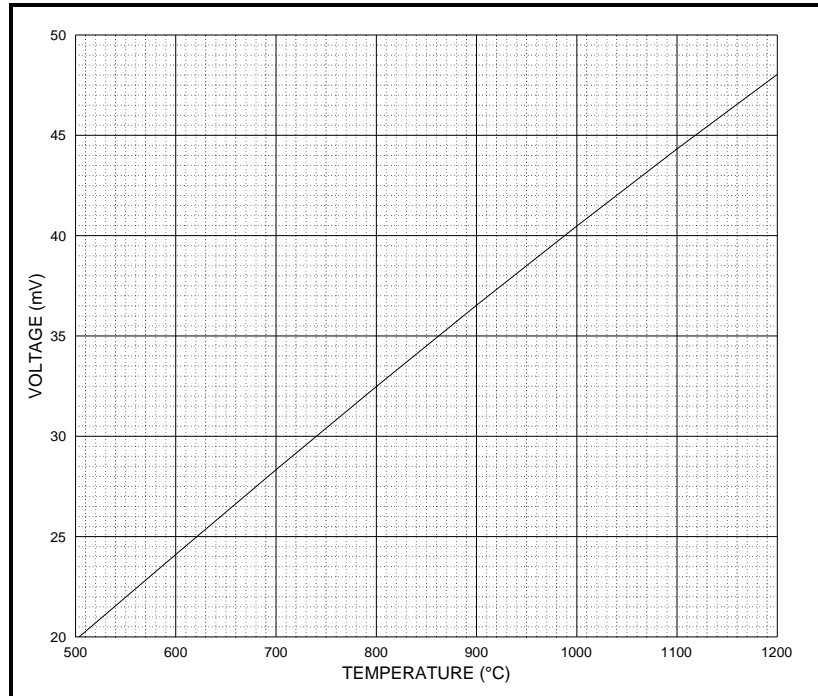

Figure 5-1: TC Voltage vs. Temperature

Table 5-2: TC Voltage vs. Temperature

Temp.(°C)	E(mV)	Temp.(°C)	E(mV)
20	(0.7981)	730	29.5841
500	19.8462	740	30.0002
550	21.9783	750	30.4153
600	24.1073	760	30.8296
610	24.5322	770	31.2429
620	24.9566	780	31.6553
630	25.3805	790	32.0668
640	25.8039	800	32.4773
650	26.2267	850	34.5150
660	26.6489	900	36.5278
670	27.0705	950	38.5154
680	27.4914	1000	40.4775
690	27.9115	1050	42.4131
700	28.3309	1100	44.3206
710	28.7494	1150	46.1973
720	29.1672	1200	48.0401

Checking the Oxygen Sensor

If the thermocouple voltage was within the normal range, the troubleshooting sequence should continue here.

Note: *For information regarding component locations and/or wiring connections in an optional enclosure, see Appendix C.*

1. Disconnect the oxygen sensor (O₂) leads (white +, -) from terminal block TB2.
2. Using a digital multimeter, measure the resistance between the two disconnected oxygen sensor leads.
3. If the measurement indicates an open loop (OL), adjust the clips to make certain they are making good contact with the oxygen sensor and take another reading. If an open loop is still measured, the oxygen sensor is defective and must be replaced.

Note: *A cold sensor will always indicate an open loop (OL).*

If the oxygen sensor tests good, proceed to the next section to continue the troubleshooting procedure.

Checking the Sensor Furnace

If the sensor furnace operating temperature was too low, the troubleshooting sequence should resume here.

Note: *For information regarding component locations and/or wiring connections in an optional enclosure, see Appendix C.*

1. Disconnect the sensor furnace (HEATER) leads (white 1, 2) from terminal block TB2.
2. Using a digital multimeter, measure the resistance across the disconnected sensor furnace leads. One of the conditions listed in Table 5-3 below should occur.

Table 5-3: Sensor Furnace Resistance Reading

Resistance Reading	Recommended Action
approx. 66 ohms	The sensor furnace is good - check the furnace voltage input (see page 5-6).
open loop (OL)	The sensor furnace is bad - replace the sensor furnace (see page 5-18).

Note: *The sensor furnace impedance may also be checked in the User Program. Proceed to the Diag>Impedance prompt, as described on page 4-37 (also, see Figure 3-2 on page 3-9), and display the current value.*

3. If the sensor furnace is good, reconnect the sensor furnace leads to terminal block TB2.

Based on the recommended action in Table 5-3 above, proceed to the appropriate section for further instructions.

Checking the Sensor Furnace Voltage

If the sensor furnace impedance test indicated that the sensor furnace is good, continue the troubleshooting procedure here.

Note: *For information regarding component locations and/or wiring connections in an optional enclosure, see Appendix C.*

1. Using a digital multimeter, measure the sensor furnace AC input voltage on terminal block TB2. See Figure 2-2 on page 2-10 for the location of TB2 and the HEATER pins. One of the conditions listed in Table 5-4 below should occur.

Table 5-4: Furnace Voltage Reading

Voltage Reading	Recommended Action
approximately full line voltage	Defective digital display unit - replace the digital display (see page 5-22).
no voltage present	There is no power reaching the sensor furnace - proceed with the next step.

2. Remove the terminal board fuse (see Figure 2-2 on page 2-10) and check it for continuity. If the fuse is blown, replace it with a new fuse of the same size and type listed in Chapter 6, *Specifications*.
3. If the fuse was good, the main voltage supply is bad. Check the external disconnect device and/or the main voltage source to that device.

Based on the recommended action in Table 5-4 above, proceed to the appropriate section for instructions. If the problem has still not been resolved at this point, contact the factory for assistance.

Oxygen Measurement Errors

This section discusses each of the following possible oxygen errors:

- oxygen concentration stuck at 20.93%
- oxygen concentration reading above 100%
- oxygen reading too low
- oxygen reading too high

Refer to the appropriate section of this chapter and to Figure 5-2 on page 5-25 for help in troubleshooting each of the above situations.

Note: *For information regarding component locations and/or wiring connections in an optional enclosure, see Appendix C.*

Oxygen Concentration Reads Constant 20.93%

This condition is unusual and is likely to be caused either by a short in the oxygen sensor wiring, a severe air leak in the plumbing or a defective digital display. A brief description of how to remedy this problem is presented below.

!WARNING!

The sensor enclosure is hot. Use heat-resistant gloves when handling the enclosure.

IMPORTANT: *This symbol indicates Caution - dangerously hot surfaces:*



Checking the Oxygen Sensor Wiring

Refer to Figure 5-2 on page 5-25 for the location of the oxygen sensor clips, and check for a short circuit in the contact clip wiring (two wires touching). If this does not correct the problem, proceed to the next section.

Note: *For information regarding component locations and/or wiring connections in an optional enclosure, see Appendix C.*

Checking for Plumbing Leaks

A plumbing leak permits cross-contamination of the reference air and the sample gas. Use the following steps to remedy the problem:

1. Make sure that the calibration gas port in the sample system has not been left open. This would admit atmospheric air into the sample system and force a 20.93% reading.
2. Open the sensor enclosure cover and check all plumbing connections for leaks. Make sure that the oxygen sensor nut and the inlet connections are properly sealed.

When the reference air is contaminated by the same gases that are being measured, the oxygen sensor generates a 0.00 mV analog output signal and a 20.93% oxygen reading. Opening the cover permits uncontaminated reference air to enter the unit. If opening the cover and fixing any plumbing leaks does not cause the 20.93% reading to drop, proceed to the next section.

3. If the oxygen reading drops in Step 2 above, tighten all fittings by 1/8 turn and close the sensor enclosure cover. If the oxygen reading gradually returns to 20.93%, try tightening the fittings an additional 1/8 turn. If the problem persists, contact the factory for assistance.

Caution!

Do not tighten fittings more than 1/8 turn at a time.

Checking the Digital Display

If the shorted wiring and plumbing leak checks have not corrected the problem, complete the following steps:

1. Disconnect the oxygen sensor (O₂) leads from terminal block TB2.
2. Connect the positive lead of a digital voltmeter to the wire (white - #1) removed from pin + and connect the negative voltmeter lead to the wire (white - #2) removed from pin -.

IMPORTANT: *The oxygen sensor leads must be removed from the terminal block for this test. If the leads are not disconnected, a short on the digital display circuit board could result in a false 0.00 mV reading.*

3. A voltage reading of 0.00 mV should be obtained, to correspond with the 20.93% oxygen reading. If any voltage other than 0.00 mV is measured, the digital display is defective. Contact the factory for assistance.

Oxygen Reading Above 100%

An oxygen display reading greater than 100% is almost always caused by reversed wiring of the oxygen sensor. For example, 4% oxygen at 700°C would generate an oxygen sensor output of +34.69 mV. However, reversed oxygen sensor wiring would cause this reading to be -34.69 mV. The Nernst equation calculation would then convert this voltage to an oxygen display of 109.49%!

- To correct this problem, check the oxygen sensor wiring at terminal block TB2 for the correct polarity (refer to Figure 2-2 on page 2-10).

Note: *For information regarding component locations and/or wiring connections in an optional enclosure, see Appendix C.*

Oxygen Reading Too Low

This condition is usually caused by combustibles in the sample gas, but it may also be the result of the oxygen sensor being out of calibration. To correct the condition, complete the following steps:

1. The sample gas may be contaminated with combustibles from grease or oil in the plumbing. The oxygen sensor will cause combustibles such as CO, H₂, or hydrocarbons in the sample to react with oxygen, thus depleting the oxygen in the sample gas. This will give a reading that may be less than the expected amount of oxygen. To fix the problem, remove the source of the contamination.
2. If the sample gas is not contaminated with hydrocarbons, recalibrate the oxygen sensor. See *Calibrating the Model CGA 351* on page 4-31, for the correct procedure.

Oxygen Reading Too High

This condition is most likely caused either by poor quality reference air, a leak in the plumbing or an oxygen sensor that is too cool. A brief description of possible solutions to this problem is presented on page 5-10.

!WARNING!

The sensor enclosure is hot. Use heat-resistant gloves when handling the enclosure.

IMPORTANT: *This symbol indicates Caution - dangerously hot surfaces:*



Check for Plumbing Leaks

A plumbing leak permits contamination of the reference air by the sample gas. The resulting reduction in the ratio of the oxygen partial pressures reduces the mV output from the oxygen sensor and yields a percent oxygen reading that is higher than expected. Use the following steps to remedy the problem:

1. Open the sensor enclosure cover to allow uncontaminated reference air to enter the unit.
2. If the oxygen reading drops in Step 1 above, tighten all fittings by 1/8 turn and close the sensor enclosure cover. If the oxygen reading gradually increases, repeat Step 1. If the problem persists, proceed to the next section.

Caution!

Do not tighten fittings more than 1/8 turn at a time.

Check the Oxygen Sensor Temperature

If the oxygen sensor is below its normal operating temperature, the mV output will be too low and the percent oxygen reading will be higher than expected. Proceed as follows:

- The easiest way to check the sensor temperature is to calibrate the oxygen sensor as described in “Calibrating the Model CGA 351” on page 4-31. The calibration procedure includes instructions for adjusting the sensor furnace temperature, if necessary.

If the problem has not been resolved by the steps in this section, contact the factory for assistance.

Calibration Responses

Chapter 4, *Setup and Calibration*, describes the procedures for calibrating the CGA 351 in great detail. However, the response of the unit to the calibration procedures can provide valuable clues to potential problems with the installation. The three most common situations are described in this section.

Everything Is Fine

Calibration of the analyzer at the tagged calibration gas flow rate has been successfully completed. Upon switching off the calibration gas, the analyzer quickly returns to monitoring and displaying the sample gas concentrations accurately. This indicates that proper operating conditions have been achieved and the analyzer can be expected to perform reliably.

Forced Flow Problem

If a flow rate higher than the tagged calibration gas flow rate is required to calibrate the analyzer, the sample gas feed pressure is too high. Under such conditions, the sample is not entering the oxygen sensor by diffusion only, but it is being forced into the sensor instead. In addition to the calibration problem, sensor life may be shortened and analyzer plugging may occur. If forced flow is confirmed as the problem, refer to Chapter 2, *Installation*, for instructions on proper installation of the analyzer.

Plugging or Dead Space Problem

The analyzer was successfully calibrated at the tagged calibration gas flow rate, and the analyzer responded quickly to the calibration gas. However, there is a significant delay in reading the correct sample gas concentrations, after turning off the calibration gas.

When this problem occurs, it is very likely that the sample gas inlet is located in a dead space. After the analyzer is correctly reading the sample gas concentration, switch on the calibration gas just long enough to get the correct reading. As soon as the analyzer reads the correct value, quickly shut off the calibration gas. One of two responses should occur:

1. If the recovery time is still too long, the sample gas path through the oxygen sensor may be plugged with particulates. Use of a blowback system (contact the factory for assistance) should clear the analyzer and restore proper operation.
2. If the analyzer reading recovers promptly, *dead space* is the likely problem. Internal structures can cause dead spaces that are not evident from an external examination. It may sometimes be necessary to relocate the analyzer to a more suitable installation site.

Note: *If the calibration “Failed”, repeat the calibration procedure on pages 4-33 to 4-35. If another failure or any situations not covered in this chapter are encountered, contact the factory for assistance.*

Parts Replacement

The CGA 351 is designed to enable easy and quick servicing, if necessary. This section describes the replacement of major and minor components of the analyzer. However, before actually replacing any component, carefully read the complete instructions to become familiar with the procedures.

Each procedure in this section includes a list of the equipment needed to complete the component replacement. Please make sure that any necessary replacement parts are on hand before dismantling the analyzer. In addition, the first paragraph of each section gives a description of the function and location of the part to be replaced. refer to Figure 5-2 on page 5-25, while following the step-by-step instructions in this section.

Note: *For information regarding component locations and/or wiring connections in an optional enclosure, see Appendix C.*

Caution!

If the power must be disconnected to replace a part, perform the replacement as quickly as possible. The CGA 351 is susceptible to corrosion from acid condensation if it remains without power for more than thirty minutes.

If service procedures not covered in this chapter become necessary, please contact the factory for assistance.

!WARNING!

To ensure safe operation of the CGA 351, it must be installed and operated as described in this manual. In addition, be sure to follow all applicable local safety codes and regulations for installing electrical equipment. In addition, all procedures should be performed by trained service personnel.

IMPORTANT: *These symbols indicate Caution - dangerously hot surfaces and risk of electric shock, respectively:*



The Sensor Enclosure

Those components associated with the oxygen measurement process are located in the sensor enclosure. This section describes the proper procedures for replacing these parts.

!WARNING!

There are extremely hot surfaces in the sensor enclosure. If these surfaces are touched, serious burns could result. Always wear heat-resistant gloves while performing these procedures.

IMPORTANT: *These symbols indicate Caution - dangerously hot surfaces and risk of electric shock, respectively:*



Caution!

Rapid cooling of the oxygen sensor will result in cracks in the ceramic that will render the sensor unusable. Before opening the door to the sensor enclosure, allow about two hours after the system is powered down for the sensor to cool slowly.

Proceed to the appropriate section to replace the desired component.

Replacing the Oxygen Sensor Clips

The oxygen sensor is connected to the electronics via two contact clips located at the base of the sensor. The *upper clip* is electrically isolated from the *lower clip* by a non-conductive band on the sensor body. Both clips simply snap around the body of the sensor.

The following tools are needed to replace the oxygen sensor clips:

- pliers
- wire cutters
- wire strippers
- crimping tool

Power may remain on while completing the following steps:

1. Open the sensor enclosure cover.
2. Locate the oxygen sensor and the oxygen sensor clips (see Figure 5-2 on page 5-25).

Note: *For information regarding component locations and/or wiring connections in an optional enclosure, see Appendix C.*

IMPORTANT: *Never touch the coating on the oxygen sensor with bare hands.*

3. Use pliers to remove the upper and lower clips from the oxygen sensor. The clips are easily removed by pulling them away from the oxygen sensor body.
4. Cut off the old upper clip, leaving the remaining wire as long as possible.
5. Strip 1/2" of insulation off the upper clip wire, and slide the new upper clip over the stripped wire. Using a crimping tool, crimp the new upper clip onto the upper clip wire.
6. Repeat steps 4 and 5 to install the new lower clip.
7. Reinstall both clips onto the oxygen sensor body.
8. Close the cover on the sensor enclosure.
9. Recalibrate the oxygen sensor as described in "Calibrating the Model CGA 351" on page 4-31.

This completes the replacement of the oxygen sensor clips.

Replacing the Oxygen Sensor Assembly

The oxygen sensor assembly is mounted beneath the sensor furnace and is readily accessible for quick and easy replacement. The following items are needed to replace the oxygen sensor:

IMPORTANT: *For proper operation in the low ranges, the oxygen sensor assembly must be replaced as a unit. Never attempt to replace just the oxygen sensor itself.*

- adjustable wrench
- screwdriver
- pliers

Caution!

When replacing the oxygen sensor assembly, do not touch the new oxygen sensor with bare hands. Handle the assembly by the mounting plate and/or manifold.

IMPORTANT: *These symbols indicate Caution - dangerously hot surfaces and risk of electric shock, respectively:*



To remove the defective oxygen sensor assembly, proceed as follows:

!WARNING!

There are extremely hot surfaces in the analyzer. Touching these surfaces will result in serious burns. Use heat-resistant gloves while replacing the oxygen sensor.

1. Remove the inlet and outlet process connections, and open the sensor enclosure cover.
2. Locate the oxygen sensor and the oxygen sensor clips (see Figure 5-2 on page 5-25). Use pliers to remove the upper and lower clips from the oxygen sensor. The clips are easily removed by pulling them away from the oxygen sensor body.
3. Remove the four screws that secure the sensor/manifold mounting plate to the bottom of the sensor enclosure. Make sure that the sensor does not hit the sides of the sensor furnace, and carefully slide the sensor assembly out of the enclosure.

IMPORTANT: *Note the orientation of the mounting plate and the manifold while removing the assembly.*

*Replacing the Oxygen
Sensor Assembly (cont.)*

To install the new oxygen sensor, complete the following steps:

Caution!

When replacing the oxygen sensor assembly, do not touch the new oxygen sensor with bare hands. Handle the assembly by the mounting plate and/or manifold.

1. Insert the sensor/manifold assembly through the opening in the bottom of the sensor enclosure and into the sensor furnace. Make sure that the assembly is oriented in the same way as the old assembly.

Caution!

If the sensor furnace is hot, insert the new oxygen sensor slowly. Take 45-60 seconds to fully insert the sensor into the furnace. If the sensor is inserted too quickly, it will crack.

2. Secure the mounting plate to the bottom of the enclosure with the four screws previously removed.
3. Reinstall the upper and lower clips onto the oxygen sensor body.
4. Connect the inlet and outlet process fittings to the bottom of the sensor enclosure.
5. Close the cover on the sensor enclosure.
6. Calibrate the new oxygen sensor as described in “Calibrating the Model CGA 351” on page 4-31.

This completes the replacement of the oxygen sensor assembly.

Replacing the Thermocouple

The thermocouple is mounted on the bottom of the sensor furnace and extends approximately 2–3 in. into the sensor furnace.

Note: *For information regarding component locations and/or wiring connections in an optional enclosure, see Appendix C.*

Caution!

To prevent damage, the oxygen sensor must cool for about two hours after the unit is powered down before the sensor enclosure door may be opened. Then, replace the thermocouple and reconnect the power as quickly as possible to prevent corrosion of the analyzer components due to acid condensation.

IMPORTANT: *These symbols indicate Caution - dangerously hot surfaces and risk of electric shock, respectively:*



A standard screwdriver is the only tool needed for replacement of the thermocouple. Complete the following steps, in the order shown, to remove the defective thermocouple:

1. Disconnect the main power to the CGA 351.

!WARNING!

Failure to cut the main power at the external disconnect device before proceeding will result in serious personal injury.

2. Open the cover on the sensor and electronics enclosures.

!WARNING!

The sensor furnace may still be hot. Always use heat-resistant gloves when handling it.

3. Remove the oxygen sensor/manifold assembly, as described in the previous section.
4. Disconnect the thermocouple leads from TB2 in the electronics enclosure (make a note of the terminal pins for each lead), and pull the leads through the conduit and into the sensor enclosure.
5. Remove the screw that secures the integral thermocouple clamp to the bottom of the sensor furnace.

Replacing the Thermocouple (cont.)

6. Extract the thermocouple from the sensor furnace, through the opening in the bottom of the sensor enclosure.

Install the new thermocouple by completing the following steps:

1. Insert the new thermocouple into the sensor furnace, being careful not to strike it against the heating element or the pipe wall inside the sensor furnace.
2. Secure the thermocouple clamp to the bottom of the sensor furnace with the screw previously removed.
3. Route the thermocouple wires through the conduit and into the electronics enclosure.
4. Connect the thermocouple wire leads to the same pins from which the old leads were removed. The positive (yellow) and negative (red) leads must be connected with the correct polarity.
5. Reinstall the oxygen sensor/manifold assembly into the bottom of the sensor enclosure and install the upper and lower oxygen sensor clips, as described in the previous section.
6. Close the covers on both enclosures.
7. Energize the main power to the meter and calibrate the oxygen sensor (see “Calibrating the Model CGA 351” on page 4-31).

This completes the replacement of the thermocouple.

Replacing the Sensor Furnace

The sensor furnace, which maintains the oxygen sensor at a stable operating temperature, is located in the sensor enclosure and is easily replaceable. The following tools are required:

- screwdriver
- digital multimeter

Caution!

To replace the sensor furnace, the power to the CGA 351 must be disconnected. Therefore, replace the sensor furnace and reconnect the power as quickly as possible to prevent corrosion of the analyzer components due to acid condensation.

IMPORTANT: *These symbols indicate Caution - dangerously hot surfaces and risk of electric shock, respectively:*



Replacing the Sensor Furnace (cont.)

Complete the following steps, in the order given, to remove the old sensor furnace:

1. Disconnect the main power to the CGA 351.

!WARNING!

Failure to cut the main power at the external disconnect device before proceeding will result in serious personal injury.

2. Open the cover on the sensor enclosure.

!WARNING!

The sensor furnace may still be hot. Always use heat-resistant gloves when handling it.

3. Remove the oxygen sensor/manifold assembly and the thermocouple, as described in the previous sections (see pages 5-15 and 5-17).

Note: *For information regarding component locations and/or wiring connections in an optional enclosure, see Appendix C.*

4. Free the sensor furnace from its mounting bracket by removing the two screws on the top and bottom of the furnace, and lift the sensor furnace out of the enclosure.
5. Locate the ceramic block on the bottom of the sensor furnace and loosen the two (2) terminal screws closest to the outer edge of the sensor furnace.

IMPORTANT: *Do not completely remove the terminal screws from the ceramic power block.*

6. Carefully remove the two leads from the loosened terminal screws near the outer edge of the sensor furnace.

This completes the removal of the old sensor furnace. Install the new sensor furnace immediately, by completing the following instructions:

1. Locate the ceramic block, which is located on the bottom surface of the new sensor furnace.
2. Feed each of the previously removed sensor furnace wires through the outside, then the inside, of the ceramic block. Reconnect the two wires to the outer terminals on the ceramic block.

*Replacing the Sensor
Furnace (cont.)*

3. Make sure the internal power leads are fed all the way through the ceramic block, in order to make a good connection, and that they exit on the opposite side from which they were inserted. Tighten all four (4) terminal screws on the ceramic block.
4. Using a digital multimeter, check the resistance of the sensor furnace heating element. Specific instructions may be found on page 5-5.
5. Reinstall the thermocouple and the oxygen sensor/manifold assembly into the sensor enclosure, as described on page 5-16 (starting with step 3).
6. Close the cover on the sensor enclosure.
7. Reconnect the main power to the unit and recalibrate the oxygen sensor (see *Calibrating the Model CGA 351* on page 4-31).

This completes the replacement of the sensor furnace.

The Electronics Enclosure

Those components associated with the electronic conditioning of the signals generated by the oxygen measurement components are located in the electronics enclosure. This section describes the proper procedures for replacing these parts.

The user-serviceable parts located in the electronics enclosure (see Figure 2-2 on page 2-10) include the following:

- main power fuse
- digital panel meter
- controller card
- option card(s)

Proceed directly to the appropriate section to replace any of the above components.

Note: *For information regarding component locations and/or wiring connections in an optional enclosure, see Appendix C.*

Replacing the Fuse

If the main power fuse is defective, install a new fuse by completing the following steps:

Note: *For information regarding component locations and/or wiring connections in an optional enclosure, see Appendix C.*

1. Disconnect the main power to the CGA 351.

!WARNING!

Failure to cut the main power at the external disconnect device before proceeding will result in serious personal injury.

2. Remove the cover beneath the digital display panel on the electronics enclosure.
3. Locate the fuse holder (see Figure 2-2 on page 2-10) on the lower right side of the terminal board. Remove the old fuse.
4. Install a new fuse of the same type and rating. See Chapter 6, *Specifications*, for the correct fuse to use.
5. Install the cover on the electronics enclosure, and reapply power to the analyzer.

The CGA 351 may now be placed back into service.

Replacing the Digital Panel Meter

If the digital panel meter is defective, remove the defective meter by completing the following steps:

Note: *For information regarding component locations and/or wiring connections in an optional enclosure, see Appendix C.*

1. Disconnect the main power to the CGA 351.

!WARNING!

Failure to cut the main power at the external disconnect device before proceeding will result in serious personal injury.

2. Remove the four sets of mounting hardware and remove the electronics enclosure from its mounting surface.
3. Remove the eight screws on the rear of the enclosure and lift the mounting plate off the enclosure.
4. Make a sketch of all wiring connections to the rear of the digital panel meter, and then disconnect all the wiring.
5. Remove the two mounting brackets and push the panel meter out through the front of the enclosure. Remove the controller and option cards from Slots 1 and 2, respectively.

Install the new meter by completing the following steps:

1. Install the original controller and option cards into Slots 1 and 2, respectively, of the new meter.
2. Insert the new meter through the opening in the front of the electronics enclosure and secure it in place with the two brackets.
3. Reconnect all of the wires to the connectors on the rear of the new digital panel meter.
4. Place the mounting plate over the rear of the electronics enclosure and secure it with the eight screws previously removed.
5. Mount the electronics enclosure back onto the wall/panel and secure it with the four sets of hardware previously removed.
6. Reconnect the main power to the analyzer.
7. Refer to Chapter 3, *Operation*, and Chapter 4, *Setup and Calibration*, to reprogram the new digital panel meter.

The CGA 351 is now ready to be placed back into service.

Replacing the Controller Card

To replace a defective controller card, complete the following steps:

Note: *For information regarding component locations and/or wiring connections in an optional enclosure, see Appendix C.*

1. Disconnect the main power to the CGA 351.

!WARNING!

Failure to cut the main power at the external disconnect device before proceeding will result in serious personal injury.

2. Remove the panel meter, as described in the previous section (see page 5-22).
3. Remove the defective controller card from Slot 1 of the panel meter, and install the new controller card in its place.
4. Reinstall the panel meter into the electronics enclosure, as described in the previous section above.
5. Reconnect the main power to the analyzer.
6. Refer to Chapter 3, *Operation*, and Chapter 4, *Setup and Calibration*, to reprogram the new digital panel meter.

The CGA 351 is now ready to be placed back into service.

Replacing the Option Card To replace a defective option card, complete the following steps:

Note: *For information regarding component locations and/or wiring connections in an optional enclosure, see Appendix C.*

1. Disconnect the main power to the CGA 351.

!WARNING!

Failure to cut the main power at the external disconnect device before proceeding will result in serious personal injury.

2. Remove the panel meter, as described in a previous section (see page 5-22).
3. Remove the defective option card from Slot 2 of the panel meter, and install the new option card in its place.
4. Reinstall the panel meter into the electronics enclosure, as described in a previous section (see page 5-22).
5. Reconnect the main power to the analyzer.
6. Refer to Chapter 3, *Operation*, and Chapter 4, *Setup and Calibration*, to reprogram the new digital panel meter.

The CGA 351 is now ready to be placed back into service.

Recommended Spare Parts

Table 5-5: Spare Parts List - CGA 351

Part Number	Qty	Description
1214-510	2	Outer Oxygen Sensor Clip
238-085	1	Thermocouple (K-Type) Temperature Detector Assembly
705-950	1	Inlet Ceramic Tube Fitting, platinum mesh included
705-952	1	Zirconium Oxide Oxygen Sensor Assembly with manifold
227-007	1	Furnace
183-047	1	LCD Display PCB
703-1304-01	1	Controller Card (256KB SRAM)
703-1320-02	1	Power Supply PCB
703-1350	1	Basic I/O PCB
703-1361-01	1	Quad Alarm PCB (32K EPROM)
703-1376	1	CGA351 Sensor PCB
703-1362	1	CGA351 Interconnect PCB

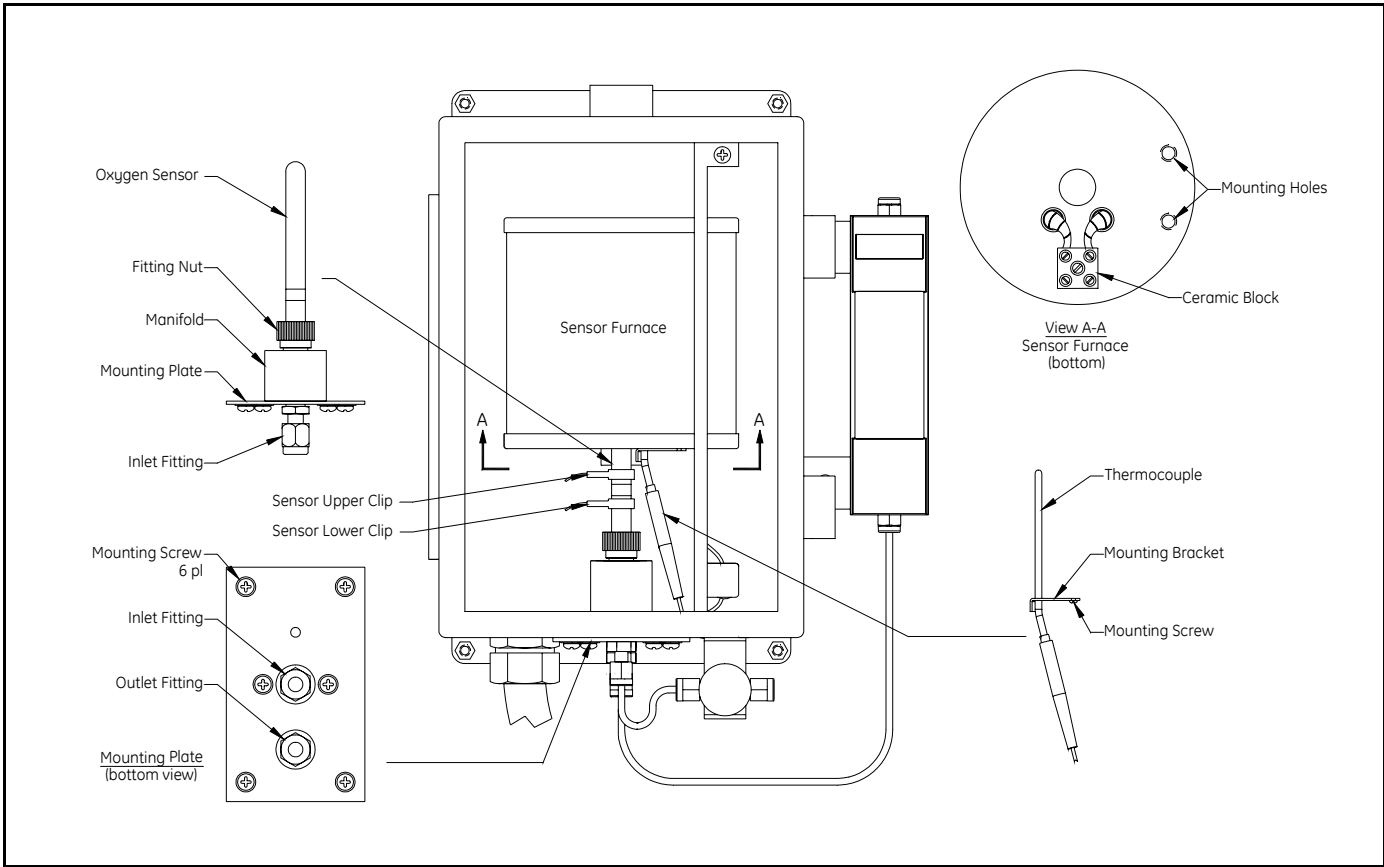

Figure 5-2: Model CGA 351 Parts Replacement

Chapter 6

Specifications

- General Specifications 6-1
- Operating Specifications 6-2
- Ordering Information 6-3

General Specifications**Accuracy:**

0.1 ppm from 0 to 5 ppm
± 2% of reading for all other ranges

Repeatability:

± 0.2% of reading

Reproducibility:

± 0.2% of reading in 24 hours
± 1% of reading in 30 days

Response Time:

less than 1 sec for 90% of step change

Stability:

drift less than 0.1% of sensor output per month

Operating Temperature:

Typical: 700°C
Maximum: 950°C

Ambient Temperature Influence:

no effect

Atmospheric Pressure Influence:

no effect, if sampling gas is vented to atmosphere
otherwise, 0.13% of reading per mm of Hg

Sample Flow Rate Influence:

no effect, if sample flow rate = 1,000 ± 150 cc/min
(2.1 ± 0.3 SCFH)

Line Voltage Influence:

no effect on sensor output

Background Gas Variation Effect:

no effect, if sample gas is clean, dry and free of combustibles

Enclosures:

NEMA 4X/IP66, stainless steel

Operating Specifications **Measuring Range:**

Any portion of the range: 0.1 ppm – 100% O₂ (field-selectable)

Standard Range: 0.1 – 10 ppm O₂

Output Range:

0/4 – 20 mA, 0 – 2 V (digital panel meter output)

0 – 1000 mV (oxygen sensor output)

Communications:

Standard RS232/RS485 Serial Port

Alarm Circuits:

Dual alarm contacts,

Contact rating: 3A at 230 VAC; SPDT

Sample Flow Rate Requirements:

1,000 ± 150 cc/min (2.1 ± 0.3 SCFH)

Ambient Requirements:

Relative Humidity: 0 – 90%

Temperature: –25 to +50°C (–13 to 122°F)

Power Requirements:

110/115 or 220/230 VAC; 50/60 Hz; 250 W max.

Fuse:

110/115 VAC: 3 A, 250 V, 5x20 mm, anti-surge

220/230 VAC: 1-1/2 A, 250 V, 5x20 mm, anti-surge

European Compliance:

This unit complies with EMC Directive 89/336/EEC, 73/23/EEC Low Voltage Directive (Installation Category II, Pollution Degree 2), and Pressure Equipment Directive 97/23/EC in accordance with Article 3, Paragraph 3.

Wetted Materials:

316 stainless steel, ceramic and platinum

Connections:

Sample Inlet and Outlet: 1/8" Swagelok Fittings

Power Cable Inlet: 1/2" conduit

Miscellaneous:

Warm Up Time: 30 minutes

Calibration Gas: certified mixtures of 5 ppm O₂ in N₂

Ordering Information

The information below shows how the CGA 351 Analyzer Part Number is configured from the options specified.

B
C
D
 CGA351-

Table 6-1: CGA351 Oxygen Analyzer Ordering Information

LTR	CATEGORY	OPTIONS
B	Voltage	1 = 100 VAC 2 = 115 VAC 3 = 220 VAC 4 = 240 VAC
C	Package	1 = Standard Design on wall mount plate 2 = Rack Mount
D	Inlet/Outlet Tube Fitting	1 = 1/4 inch tube fitting 2 = 6mm tube fitting

Appendix A

The Nernst Equation

Introduction.....	A-1
Equilibrium Conditions	A-1
The Model CGA 351 Nernst Equation	A-2

Introduction

The CGA 351 zirconia oxygen analyzer uses the *Nernst Equation* to calculate the oxygen content of the sample gas. When a Yttrium-doped zirconium oxide ceramic is heated to a temperature above 650°C, it becomes an electrolytic conductor, as vacancies in the crystal lattice permit oxygen ions to diffuse into the ceramic.

If there are different oxygen partial pressures on the two sides of the ceramic cell, oxygen ions will migrate along the resulting *concentration gradient*. This constitutes a transfer of electrons from one face of the ceramic to the other. If the transferred charge is allowed to accumulate, it gives rise to a *potential gradient* acting in the opposite direction, thus tending to oppose further diffusion.

Equilibrium Conditions

Under equilibrium conditions, the potential gradient exactly balances the concentration gradient. Porous coatings of a platinum catalyst on both surfaces of the ceramic cell serve as electrodes, while still allowing the oxygen molecules to penetrate the coating and diffuse into the ceramic. The measured voltage drop across the cell can be directly related to the ratio of the two oxygen partial pressures by means of the *Nernst Equation*:

$$E_{12} = \frac{RT}{nF} \cdot \ln \left[\frac{P_1}{P_2} \right] \quad (\text{A-1})$$

where,

F = the Faraday = 96,484.56 coulombs

T = absolute temperature = °K (°K = °C + 273.15°)

R = gas constant = 8.31441 volt-coulomb/mole-°K

n = # electrons transferred per molecule = 4/mole

ln = natural logarithm = 2.303 log₁₀

p₁ = O₂ partial pressure on reference gas side = 0.2093

p₂ = O₂ partial pressure on sample gas side

E₁₂ = voltage on reference face with respect to the sample face

The Model CGA 351 Nernst Equation

The Nernst Equation specifically applicable to the CGA 351 analyzer is obtained by substituting the above values into the general equation, converting the natural logarithm to the common logarithm (base 10) and converting the units for E_{12} to millivolts. This results in the following equation:

$$E_{12}(\text{mV}) = 0.049605 \cdot T \cdot \log \left[\frac{0.2093}{p_2} \right] \quad (\text{A-2})$$

The CGA 351 measures the temperature of the oxygen sensor and automatically inserts the correct value into the Nernst Equation. For example, at the standard oxygen sensor operating temperature of 700°C, Equation A-2 above becomes:

$$E_{12}(\text{mV}) = 48.273 \cdot \log \left[\frac{0.2093}{p_2} \right] \quad (\text{A-3})$$

The voltage drop across the zirconium oxide sensor, as calculated from the Nernst equation, is then sent to the linearizer circuit. The circuit produces a linear analog output that represents the percentage of oxygen in the sample gas, and this signal is available for display on the digital panel meter and/or for output to an external device.

For convenience, the standard Nernst equation for the CGA 351 zirconia oxygen analyzer (Equation A-3 above) has been converted into a graphical format. Use this graph (see Figure A-1 on page A-3) to quickly correlate the analog output voltage reading with the corresponding oxygen percentage, at the standard 700°C operating temperature of the meter. In addition, the data is presented in tabular form in Table A-1 on page A-4. This table is useful for looking up the correct mV value to enter during the calibration procedure, if the data will not be entered directly in either ppm or pcnt oxygen.

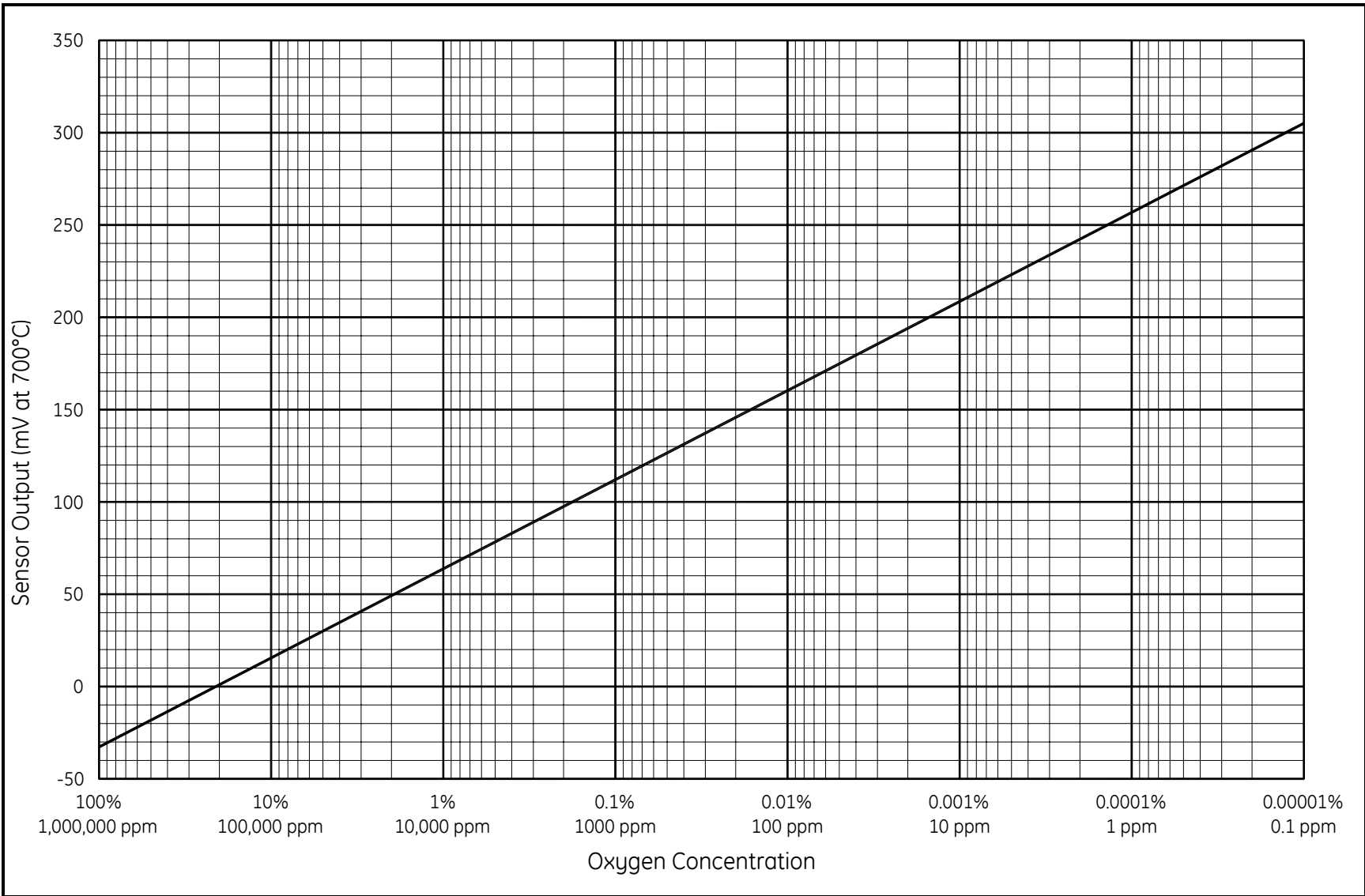

Figure A-1: Oxygen Sensor Output at 700°C

The Model CGA 351
Nernst Equation (cont.)

Table A-1: ppm to mV Conversion at 700°C

ppm	mV	ppm	mV	ppm	mV
0.1	305.122	3.6	229.995	7.1	215.757
0.2	290.591	3.7	229.421	7.2	215.463
0.3	282.090	3.8	228.862	7.3	215.174
0.4	276.059	3.9	228.317	7.4	214.889
0.5	271.381	4.0	227.786	7.5	214.608
0.6	267.559	4.1	227.269	7.6	214.330
0.7	264.327	4.2	226.763	7.7	214.056
0.8	261.528	4.3	226.270	7.8	213.785
0.9	259.058	4.4	225.788	7.9	213.518
1.0	256.849	4.5	225.317	8.0	213.255
1.1	254.851	4.6	224.856	8.1	212.994
1.2	253.027	4.7	224.405	8.2	212.737
1.3	251.349	4.8	223.964	8.3	212.483
1.4	249.795	4.9	223.532	8.4	212.232
1.5	248.349	5.0	223.108	8.5	211.984
1.5	246.996	5.1	222.693	8.6	211.738
1.7	245.725	5.2	222.286	8.7	211.496
1.8	244.527	5.3	221.887	8.8	211.256
1.9	243.393	5.4	221.495	8.9	211.020
2.0	242.318	5.5	221.110	9.0	210.785
2.1	241.295	5.6	220.732	9.1	210.554
2.2	240.320	5.7	220.361	9.2	210.325
2.3	239.388	5.8	219.997	9.3	210.098
2.4	238.496	5.9	219.638	9.4	209.874
2.5	237.640	6.0	219.286	9.5	209.652
2.6	236.817	6.1	218.939	9.6	209.432
2.7	236.026	6.2	218.598	9.7	209.215
2.8	235.264	6.3	218.263	9.8	209.000
2.9	234.528	6.4	217.933	9.9	208.787
3.0	233.817	6.5	217.608	10.0	208.576
3.1	233.130	6.6	217.288		
3.2	232.464	6.7	216.972		
3.3	231.819	6.8	216.662		
3.4	231.193	6.9	216.356		
3.5	230.586	7.0	216.054		

Appendix B

CE Mark Compliance

- Overview B-1
- EMC Compliance..... B-1
- LVD Compliance B-1

Overview

For CE Mark compliance, the CGA 351 zirconia oxygen analyzer must meet both the *EMC* and *LVD* directives.

IMPORTANT: *CE Mark compliance is required only for units used in EEC countries.*

EMC Compliance

For *EMC* compliance, the electrical connections must be shielded and grounded as shown in Table B-1 below. After all the necessary electrical connections have been made, seal any unused cable entry holes with standard conduit plugs or equivalent.

Note: *If the instructions in this appendix are followed, the unit will comply with the EMC Directive 89/336/EEC.*

Table B-1: Wiring Modifications for EMC Compliance

Connection	Wiring Modification
Power	<ol style="list-style-type: none"> 1. Use shielded* cable to connect power to the CGA 351. 2. Select the cable entry closest to the chassis ground. 3. Connect the power line ground wire and the shield* to the nearest chassis ground terminal.
Input/Output	<ol style="list-style-type: none"> 1. Use shielded* cable to interconnect the CGA 351 with any external input/output devices. 2. Connect the shields* to the nearest chassis ground terminal.
*Wires installed in properly grounded metal conduit are not required to have their own shield.	

LVD Compliance

For compliance with the European Union's Low Voltage Directive (73/23/EEC), the analyzer requires an external power disconnect device such as a switch or circuit breaker. The disconnect device must be marked as such, clearly visible, directly accessible, and located within 1.8 m (6 ft) of the CGA 351.

Note: *If the instructions in this appendix are followed, the unit will comply with the Low Voltage Directive (73/23/EEC).*

Appendix C

Optional Enclosures

- Introduction.....C-1
- Rack Mount InstallationC-1
- Rack Mount OperationC-4
- Rack Mount Service and MaintenanceC-4

Introduction

Upon request, the *Model CGA 351* analyzer may be supplied in an enclosure other than the standard NEMA-4X enclosures described in Chapter 1 of this manual, *General Information*. Although the standard installation and wiring instructions set forth in Chapter 2, *Installation*, will still apply in general terms, some of the details may vary for different enclosure types.

Rack Mount Installation

The CGA 351 analyzer is available in a rack mount enclosure for installation in a standard 19" electronics rack (see Figure C-1 below).



Figure C-1: CGA 351 Rack Mount Version

Mounting the Rack Mount Refer to Figure C-5 on page C-6 for mounting dimensions and install the rack mount CGA 351 as follows:

1. Slide the unit into the rack at the desired height.
2. Fasten the unit securely to the rack with four screws (two on either side of the front panel).

After the rack mount CGA 351 has been physically mounted into the rack, proceed to the next section for connecting the sample system.

Connecting the Sample System

For the best results, the sample system should be mounted as close to the CGA 351 analyzer as possible. See Figure C-2 below for the location of the Swagelok fittings on the rear panel, and complete the following steps:

1. Using 1/8" stainless steel tubing, connect the gas source from the sample system to the **Input Gas** fitting on the rear panel.
2. Using 1/8" stainless steel tubing, connect the **Sample Output** fitting on the rear panel to the gas discharge connection on the Sample System.

Note: *If desired, a suitable sample system may be ordered directly from the factory. The sample system would be supplied fully assembled on a flat plate with four (4) mounting holes.*

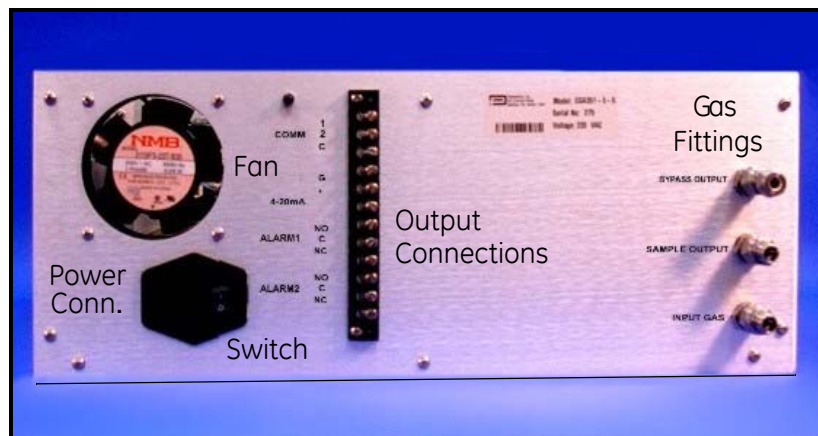

Figure C-2: CGA 351 Rack Mount Version - Rear Panel

Wiring the Rack Mount

The rack mount CGA 351 requires the same electrical connections as the standard version, but the wiring to PC Board terminal strips TB1, TB2 and TB3 has already been done at the factory. The only remaining connections to be made are at the rear panel terminal strip for those outputs being used (see Figure C-2 above and Figure C-4 on page C-5).

Connecting The Outputs

The terminal block on the rear panel provides connections for the CGA 351's output signals. The following signals are available:

- serial port
- 0/4–20 mA, 0–2 V, or Namur analog output
- alarm relays

Connecting the Outputs (cont.)

All of the connections on this terminal block are optional, in that they are not required for proper operation of the analyzer. To wire any or all of these output signals, complete the following steps which apply:

1. Connect a **serial port from a personal computer** to the *COMM* pins as follows:
 - a. Connect the *transmit* wire to pin 1.
 - b. Connect the *receive* wire to pin 2.
 - c. Connect the *ground/return* wire to pin C.
2. Connect an **analog output device** to the *4-20mA* pins as follows:
 - a. Connect the *input* wire to the external device to pin +.
 - b. Connect the *output* wire from the external device to pin -.
3. Connect **alarm device(s)** to the *ALARM 1* and/or *ALARM 2* pins as follows:
 - a. Connect the *input* wire to the alarm-1 device to pin NO.
 - b. Connect the *output* wire from the alarm-1 device to pin C.
 - c. If desired, repeat sub-steps a and b to connect alarm-2.
4. Connect any shields to pin G.

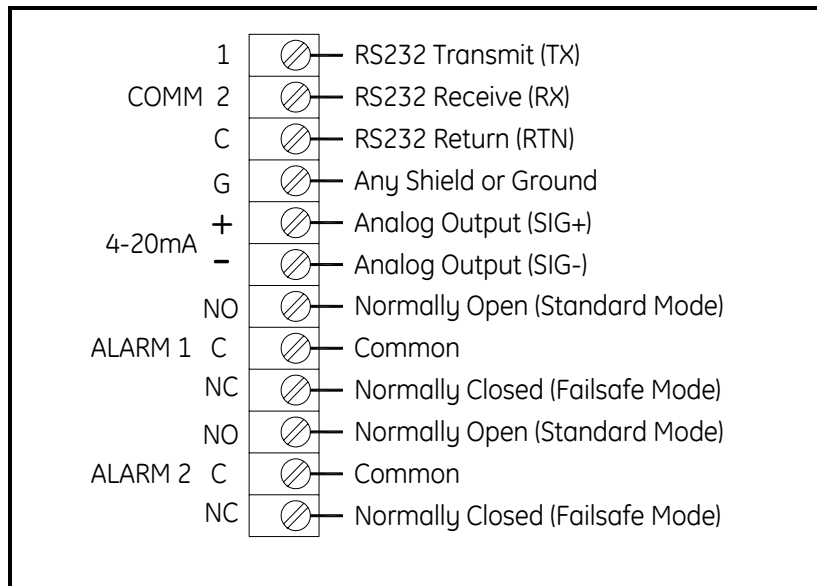

Figure C-3: Terminal Block Connections- Rear Panel

Connecting the Line Power

Caution!

Be sure that the input voltage to the CGA 351 complies with the value specified at the time of purchase.

To connect line power to the rack mount CGA 351 analyzer, use the power cable supplied with the unit. Plug one end of the cable into the connector on the rear panel and the other end into the power source, then flip the power switch to the “on” position (see Figure C-4 on page C-5).

This completes the wiring of the CGA 351 analyzer.

Rack Mount Operation

The keypad and LCD display for the rack mount CGA 351 are located on the front panel. These items are identical in form and function to those used on the standard NEMA-4X enclosure. Proceed to Chapter 3, *Operation* and Chapter 4, *Setup and Calibration*, for instructions on using the meter.

Rack Mount Service and Maintenance

To access the components and wiring in the rack mount CGA 351, it may be necessary to remove the unit from its rack. This can be accomplished by disconnecting all cables, removing the four mounting screws and sliding the unit out. The power cable may then be reconnected.

Parts Replacement

The components included in the *Rack Mount CGA 351* are basically the same as in the standard analyzer. Those included within the Sensor Enclosure are identical. Other components, however, are located differently in reference to each other. See *Rack Mount Internal Wiring Connections*, Figure C-6 on page C-7, and *Rack Mount Major Components*, Figure C-7 on page C-8, when following the procedures in Chapter 5, *Service and Maintenance*.

Replacing the Fuses

If the main power fuses are defective, see Figure C-4 below and install new fuses by completing the following steps:

1. Disconnect the main power to the Rack Mount CGA 351.
2. Insert a screwdriver blade behind the fuse access door (to the right of the power switch) and pry it open.
3. Using needle-nose pliers, pull each of the two fuse holders (with an arrow printed on the end) straight out of the unit.
4. Replace the fuses with new ones of the same type and rating. See Chapter 6, *Specifications*, for the correct fuse to use.
5. Reinsert the fuse holders, making sure the arrows are pointing down, and close the fuse access door.

The Rack Mount CGA 351 may now be placed back into service.

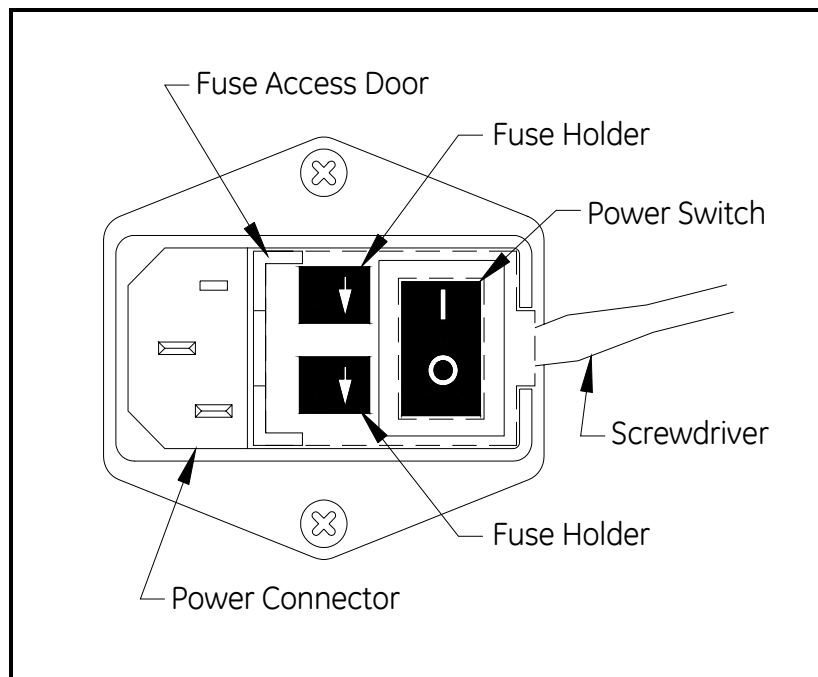

Figure C-4: Rack Mount Fuse Locations

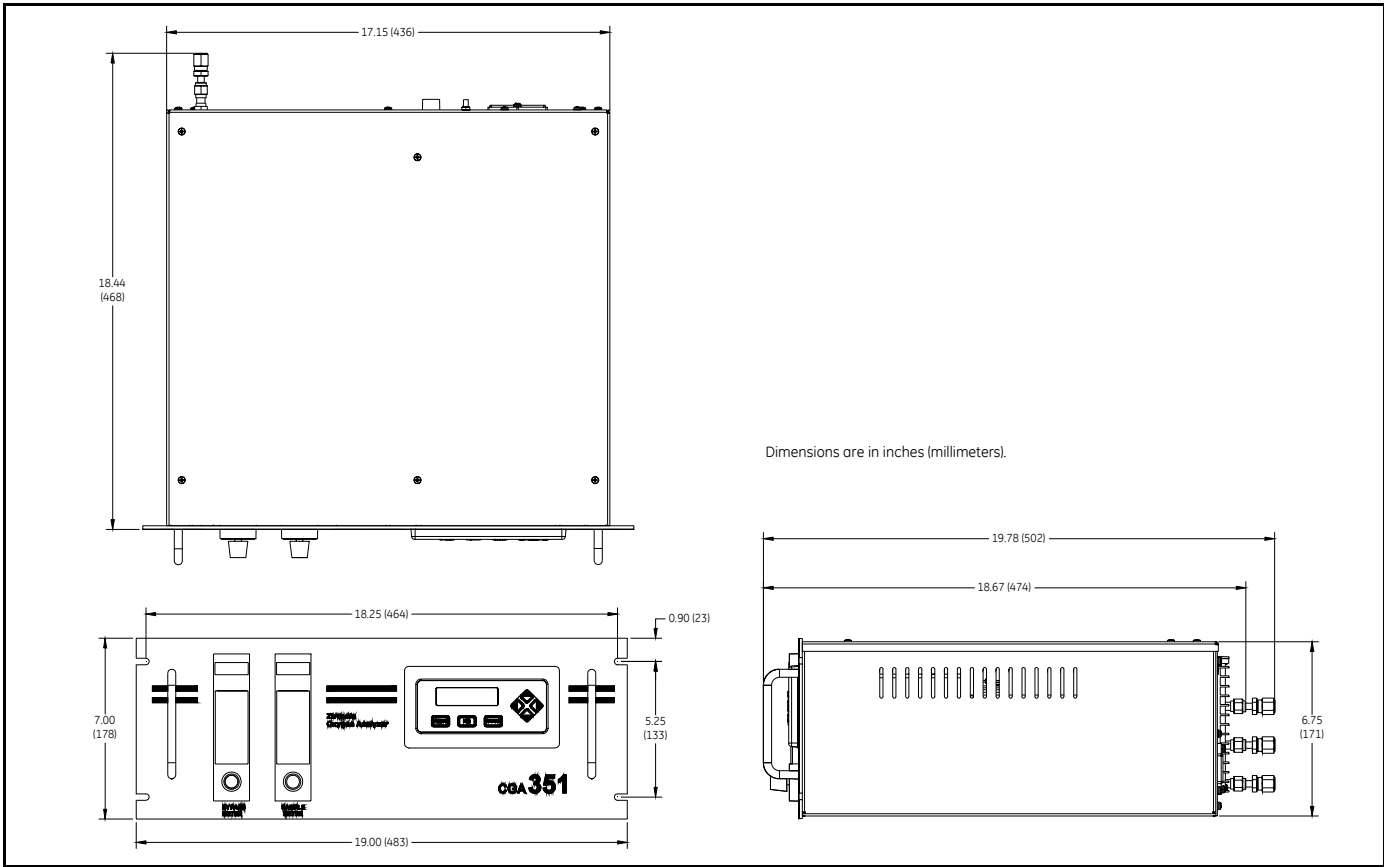

Figure C-5: CGA 351 Rock Mount Version - Outline and Mounting Dimensions

TB1 - OUTPUTS			
Group	Pin #	Description	Wire Color
COMM	1	RS232 Transmit (TX)	Brown
	2	RS232 Receive (RX)	Red
	C	RS232 Return (RTN)	Orange
ALL	G	Any Shield or Ground	Yellow
	+	Analog Output (SIG+)	Green
	-	Analog Output (SIG-)	Blue
ALARM 1	NO	Normally Open (Standard Mode)	Violet
	C	Common	Gray
	NC	Normally Closed (Failsafe Mode)	White
ALARM 2	NO	Normally Open (Standard Mode)	Black
	C	Common	White/Red
	NC	Normally Closed (Failsafe Mode)	White/Red

TB2 - INPUTS			
Group	Pin #	Description	Wire # (Color)
O2	+	Sensor (+)	1 (White)
	-	Sensor (-)	2 (White)
ALL	G	Any Gnd/Shield	N.A.
TC	+	Thermocouple (+)	N.A.(Yellow)
	-	Thermocouple (-)	N.A. (Red)
ALL	G	Any Gnd/Shield	G (White)
HEATER	1	Furnace (+)	5 (White)
	2	Furnace (-)	6 (White)

NOTE: For proper operation, the unit must be powered by the voltage specified at the time of purchase.

TB3 - POWER*		
Pin #	Description	Color
L	Line	Black
N	Neutral	White
G	Ground	Green

*90-265 VAC, 50/60 Hz, 250 W

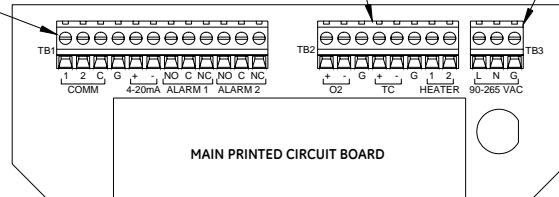

Figure C-6: CGA 351 Rack Mount Version - Internal Wiring Connections

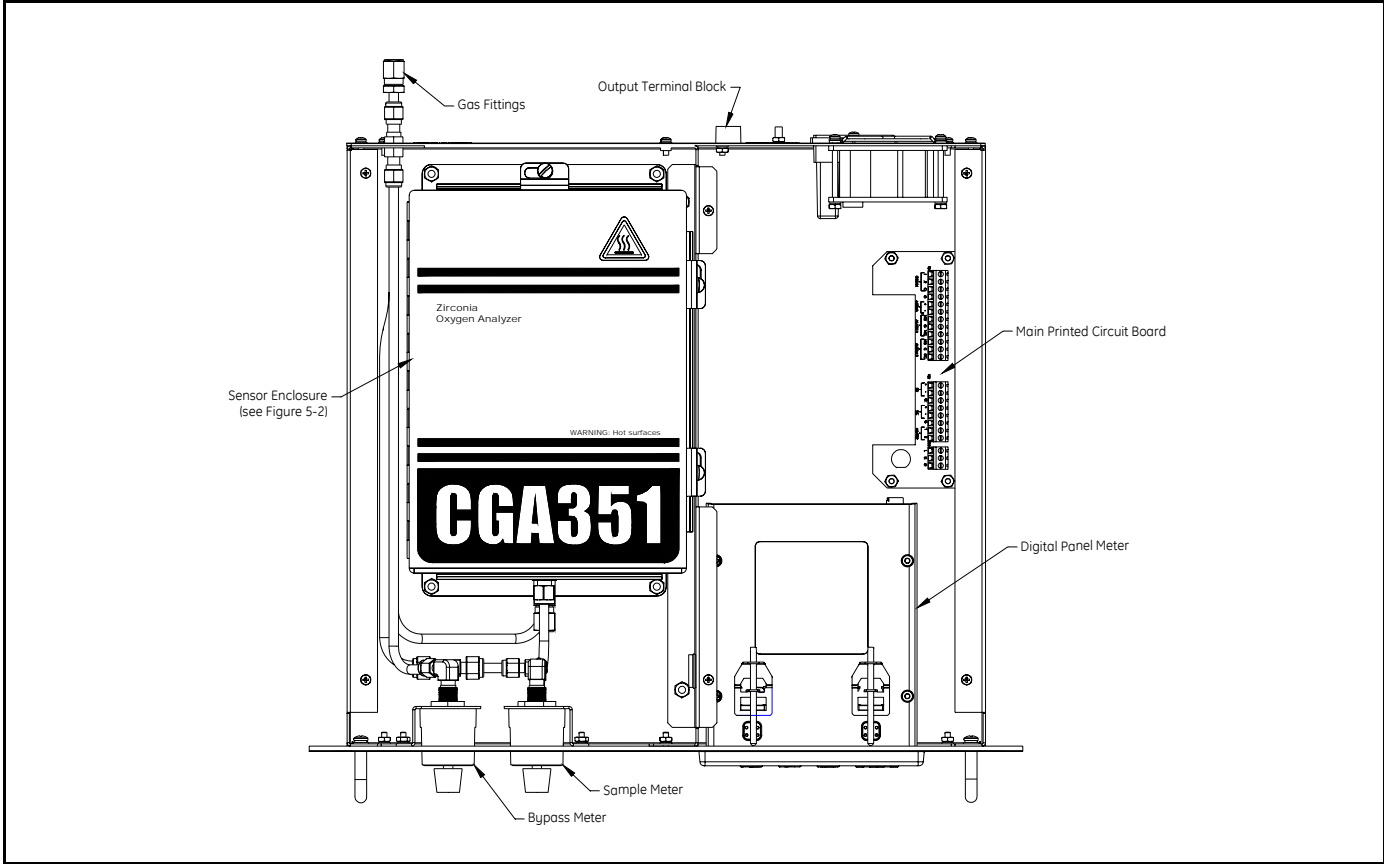

Figure C-7: CGA 351 Rack Mount Version - Major Components

Index

- A**
- Alarms
 - Deadband Value 4-5
 - Fault 4-15
 - Features 4-3
 - Mode 4-7
 - Setting Up 4-2
 - Specifications 6-2
 - Testing 4-6
 - Trip Type 4-3
 - Trip Value 4-4
 - Wiring 2-6, C-3
 - Analog Output
 - Namur 4-18
 - Output Type 4-18
 - Setting Up 4-16
 - Span Setpoint 4-20
 - Span Trim 4-23
 - Testing 4-21
 - Wiring 2-6, C-3
 - Zero Setpoint 4-19
 - Zero Trim 4-22
 - Assembly Drawing 5-25
- B**
- Backlight, Setting 4-25
 - Baud Rate 4-26
- C**
- Calibration
 - Adjusting 4-33
 - Frequency 4-1
 - Gas Flow Rate 4-32
 - Oxygen Sensor 4-31
 - Plumbing Connections 4-32
 - Recommended Gases 4-31
 - Responses 5-11
 - CE Mark Compliance B-1
 - Common Problems, Preventing 3-1
 - Connecting
 - See Part Name
 - Contrast, Adjusting 4-24
 - Controller Card, Replacing 5-23
 - Converting mV to ppm 3-8, A-4
- D**
- Data Bits 4-27
 - Dead Space 5-11
 - Diagnostic Menu 4-36
 - Digital Display
 - Backlight, Setting 4-25
 - Components 3-3
 - Configuring 3-3
 - Contrast, Adjusting 4-24
 - Multiple Windows 3-6
 - Output Devices 3-5
 - Parameters 3-5
 - Replacing 5-22
 - Testing 5-8
 - Disconnect Device 2-1, 2-3
 - Display
 - See Digital Display
- E**
- EMC Compliance B-1
 - Enclosure
 - Cover, Removing 2-5
 - Electronics 1-1
 - Mounting 2-3
 - Mounting Dimensions 2-9
 - Sensor 1-1, 1-2
 - Specifications 6-1
 - Environmental Factors 2-2
 - Errors, Oxygen 5-7
- F**
- Fault Alarm, Setting 4-15
 - Flow Rate 1-4, 4-32, 6-2
 - Flowmeter 1-2
 - Forced Flow 5-11
 - Furnace
 - Description 1-2
 - Duty Cycle 4-13
 - Replacing 5-18
 - Testing 5-5
 - Viewing Settings 4-37
 - Wiring 2-7
 - Fuse
 - Rating 6-2
 - Replacing 5-21, C-5

Index (cont.)

- | H | P |
|---|---|
| Heater
See Furnace
Heater Control 1-6 | Parity 4-27
PID Heater Control 1-6
Plumbing Leaks 5-8, 5-10
Power Requirements 6-2
Powering Up 3-2
Proportional Band 1-6, 4-11 |
| I | R |
| Installation Site
Choosing 2-2
Preparation 2-3
Integration Time 1-6, 4-12 | Rack Mount Version C-1
Range
Outputs 6-2
Percent Oxygen 6-2
Recovery Time 5-11
Replacing
See Part Name
RS232/RS485
See Serial Port
RTD
See Thermocouple |
| L | |
| Leaks, Plumbing 5-8, 5-10
Line Power, Wiring 2-8
LVD Compliance 2-1, 2-3, B-1 | |
| M | |
| Menu Map 3-9
Menus, Locking 4-30 | |
| N | |
| Needle Valve 1-2
Nernst Equation
Description A-1
Graphical Form A-2
Numeric Form A-1
Node ID 4-26 | |
| O | |
| Option Card Slots, Setting Up 4-28
Option Card, Replacing 5-24
Ordering Information 6-3
Oxygen Errors 5-7
Oxygen Sensor
See Sensor | |

Index (cont.)

S	T
Sample Gas Contamination 5-9	Temperature
Sample System	Ambient. 2-1
Mounting 2-4, C-2	Controls, Default. 4-14
Piping 2-4, C-2	Controls, Setting 4-8
Typical 1-3	Minimum. 1-4
Sensor	Operating. 6-1
Calibration 4-31	Set Point 4-9, 4-10
Clips, Replacing 5-14	Typical. 1-4
Description 1-2, 1-5	Terminal Block
Replacing 5-15	TB1 2-6
Testing 5-5	TB2 2-7
Wiring. 2-7	TB3 2-8
Sensor Furnace	Thermocouple
See Furnace	Description 1-2
Serial Port	Replacing 5-17
Baud Rate 4-26	Testing. 5-3
Data Bits 4-27	Voltage vs. Temperature. 5-4
Node ID 4-26	Wiring 2-7
Parity 4-27	Troubleshooting
Setting Up. 4-26	Diagnostic Menu 4-36
Stop Bits 4-27	Digital Display 5-8
Type 4-27	Furnace 5-5
Wiring. 2-6, C-3	Overview. 5-1
Software Versions. 4-30	Sensor 5-5
Spare Parts List 5-24	Thermocouple 5-3
Specifications	Wiring 5-2
General 6-1	
Operating 6-2	U
Stop Bits 4-27	User Program
	Accessing 3-4, 4-1
	Passwords 3-2
	Security Levels 3-2, 4-30
	W
	Warm Up Time 3-1, 3-2
	Wiring
	See Part Name
	Wiring Diagram 2-10

We,

Panametrics Limited
Shannon Industrial Estate
Shannon, County Clare
Ireland

declare under our sole responsibility that the

CGA351 Clean Gas Analyzer
CGA350GP Clean Gas Analyzer
CGA350X Clean Gas Analyzer
CGA350D Display Unit
TMO2D Display and Control Unit

to which this declaration relates, are in conformity with the following standards:

- EN 61326:1998, Class A, Annex A, Continuous Unmonitored Operation
- EN 61010-1:1993+A2:1995, Overvoltage Category II, Pollution Degree 2

following the provisions of the 89/336/EEC EMC Directive and the 73/23/EEC Low Voltage Directive.

The units listed above and any sensors and ancillary sample handling systems supplied with them do not bear CE marking for the Pressure Equipment Directive, as they are supplied in accordance with Article 3, Section 3 (sound engineering practices and codes of good workmanship) of the Pressure Equipment Directive 97/23/EC for DN<25.

Shannon - June 1, 2002



Mr. James Gibson
GENERAL MANAGER



CERT-DOC-H2



August 2004

Nous,

Panametrics Limited
Shannon Industrial Estate
Shannon, County Clare
Ireland

déclarons sous notre propre responsabilité que les

CGA351 Clean Gas Analyzer
CGA350GP Clean Gas Analyzer
CGA350X Clean Gas Analyzer
CGA350D Display Unit
TMO2D Display and Control Unit

relatif à cette déclaration, sont en conformité avec les documents suivants:

- EN 61326:1998, Class A, Annex A, Continuous Unmonitored Operation
- EN 61010-1:1993+A2:1995, Overvoltage Category II, Pollution Degree 2

suivant les règles de la Directive de Compatibilité Electromagnétique 89/336/EEC et de la Directive Basse Tension 73/23/EEC.

Les matériels listés ci-dessus, ainsi que les capteurs et les systèmes d'échantillonnages pouvant être livrés avec ne portent pas le marquage CE de la directive des équipements sous pression, car ils sont fournis en accord avec la directive 97/23/EC des équipements sous pression pour les DN<25, Article 3, section 3 qui concerne les pratiques et les codes de bonne fabrication pour l'ingénierie du son.

Shannon - June 1, 2002

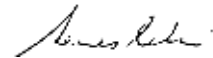

Mr. James Gibson
DIRECTEUR GÉNÉRAL



CERT-DOC-H2



August 2004

Wir,

**Panametrics Limited
Shannon Industrial Estate
Shannon, County Clare
Ireland**

erklären, in alleiniger Verantwortung, daß die Produkte

**CGA351 Clean Gas Analyzer
CGA350GP Clean Gas Analyzer
CGA350X Clean Gas Analyzer
CGA350D Display Unit
TMO2D Display and Control Unit**

folgende Normen erfüllen:

- EN 61326:1998, Class A, Annex A, Continuous Unmonitored Operation
- EN 61010-1:1993+A2:1995, Overvoltage Category II, Pollution Degree 2

gemäß den Europäischen Richtlinien, Niederspannungsrichtlinie Nr.: 73/23/EG und EMV-Richtlinie Nr.: 89/336/EG

Die oben aufgeführten Geräte und zugehörige, mitgelieferte Sensoren und Handhabungssysteme tragen keine CE-Kennzeichnung gemäß der Druckgeräte-Richtlinie, da sie in Übereinstimmung mit Artikel 3, Absatz 3 (gute Ingenieurpraxis) der Druckgeräte-Richtlinie 97/23/EG für DN<25 geliefert werden.

Shannon - June 1, 2002

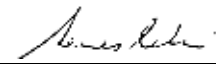

Mr. James Gibson
GENERALDIREKTOR



CERT-DOC-H2



August 2004